

PRUSA
RESEARCH
by JOSEF PRUSA



ORIGINAL INSTRUCTIONS



3D PRINTING HANDBOOK

FOR THE ORIGINAL PRUSA XL 3D PRINTER

Original Prusa XL: Official Instructions

To download the handbook in other languages, such as **Deutsch, Français, Italiano, Español, Čeština, and Polski**, visit <https://prusa3d.com/drivers> or scan the QR code on the right. This link will also take you to a hub that contains the latest downloads (firmware, handbook, drivers, PrusaSlicer) and also relevant help articles.



prusa3d.com/drivers

Official Instructions v1.04 from December 15th, 2023. For Original Prusa XL assembled, semi-assembled, single-tool and multi-tool models.

Quick Guide to the First Print

1. Read the Safety Instructions carefully (**page 9**)
2. Place the printer on a flat and stable surface (**page 17**)
3. Download the latest firmware from prusa3d.com/drivers and install it (**page 32**)
4. Calibrate the printer using the Selftest Wizard (**page 19**)
5. Insert the USB drive that came with your printer and print your first object (**page 28**)



Tips, useful pieces of advice, or important information that will help you when working with the printer are in orange boxes.



This part of the text is very important, please read it carefully! It depends on both the correct operation of the printer and its safe operation.



This information applies to the Original Prusa XL 3D printer kit.

How to contact Prusa Research technical support:

First, check the last sections of this manual that deal with common problems, or go to help.prusa3d.com where you will find a complete list of the most common problems and their solutions. If your problem is not listed here, or the solution does not work, please send an email to info@prusa3d.com and/or use our chat at prusa3d.com. Try to describe your problem as accurately as possible - ideally include pictures or videos.

JOSEF PRUSA®, PRUSA RESEARCH®, PRUSA POLYMERS®, PRUSA ORANGE®, ORIGINAL PRUSA®, PRUSA 3D®, and PRUSAMENT® are registered trademarks of Prusa Development a.s. used by Prusa Research a.s. under license from Prusa Development a.s. | JOSEF PRUSA, ORIGINAL PRUSA, and PRUSAMENT are registered trademarks (or trademark applications) of Prusa Development a.s. and are used by Prusa Research a.s. under license from Prusa Development a.s. in the following countries: Australia, New Zealand, Israel, Mexico, South Korea, Turkey, Ukraine, Russia, Kazakhstan, Switzerland, China, Colombia, Uzbekistan, Philippines and Norway. | All other company names and product names mentioned in this publication are trademarks and registered trademarks of their respective companies.

About the Author

Josef Průša (*23. 2. 1990) developed an interest in 3D printing when he began studying at the University of Economics in 2009 - it started off as a hobby, a new technology open to modifications and improvements. The hobby quickly became his passion, and Josef became one of the main developers of the international open-source (all works are freely available for any use) RepRap project by Adrian Bowyer. Today, Prusa's design in various versions can be seen all over the world; it is one of the most used printer designs. The goal is to increase public awareness of 3D printing technology.

All of Josef Průša's 3D printers are open-source. In the spirit of the RepRap project, you can use your printer to produce parts for other 3D printers.

The Original Prusa product range is constantly being expanded with new models and improvements. The main goal is to make 3D printing technology more understandable and easier for ordinary users.

Josef Průša also holds workshops for the public, participates in professional conferences, and promotes 3D printing. He has lectured at TEDx conferences in Prague and Vienna, at the World Maker Faire in New York, at the Maker Faire in Rome, and at the Open Hardware Summit at MIT. He has also taught the Arduino course at Charles University and was a lecturer at the Academy of Arts, Architecture and Design in Prague.

In his own words, he envisions a not-so-distant future where 3D printers will be available in every household. If anything is needed, you can easily print it. The boundaries in this field are being pushed every day... We are glad you are part of it!



Table of contents

1. Introduction	12
2. Original Prusa XL Overview and Glossary	13
2.1. Contents of the Package and Accessories	17
2.2. How to Move the Printer	17
2.3. Disconnecting the Power Source	18
2.4. Error Screens	18
3. Your First Print	19
3.1. Basic controls	19
3.2. Initial One-Time Calibration (Selftest)	20
3.3. Preparing Flexible Print Sheets	21
3.4. Running the Selftest	23
3.5. Dock and Tool Offset Calibration (Multi-Tool printers only)	24
3.6. Filament Sensor Calibration	24
3.7. Inserting filament	25
3.8. Removing Filament	27
3.9. Starting the First Print	28
3.10. Removing a Printed Object from the Print Sheet	29
3.11. First Print Troubleshooting	30
3.11.1. First layer peeling off from the bed	30
3.11.2. Nozzle moves too high/low, or extrudes plastic outside the print area	30
3.11.3. The nozzle does not start extruding, even after multiple attempts	30
3.11.4. After a few hours of printing, the nozzle stops extruding filament	30
3.11.5. Individual tools are not picked up or parked correctly	31
3.11.6. Filament is extruded either too high or too low.	31
3.11.7. The machine produces a rattling sound	31
3.11.8. The filament sensor does not detect filament	31
3.11.9. The printer displays an error related to communication with extruder(s).	31
3.11.10. The printer does not turn on	31
3.12. Updating the Firmware	32
3.13. Sample Models	33
3.14. Factory Reset	33
4. Advanced User Guide	34
4.1. Prusa Academy Courses	34
4.2. Network Connection	35
4.3. Obtaining Printable Models	36
4.4. Create Your Own Model	37
4.5. What is a G-code File?	37
4.6. PrusaSlicer	38
4.7. PrusaSlicer Interface Explained	39
4.7.1. Initial Setup and General Workflow	40
4.7.2. Using Supports	41
4.7.3. Speed vs Print Quality	42
4.7.4. Infill	43
4.7.5. Brim	43
4.7.6. Printing Objects Larger than the Print Volume	44
4.7.7. Printing Multicolored Objects (Single-Tool XL)	45
4.8. Printing in Multi-Material Mode	46
4.8.1. Importing Objects into PrusaSlicer	46
4.8.2. Setting up Colors	48
4.8.3. Coloring an Object	50

4.8.4. Priming Tower	52
4.8.5. Priming Tower Placement	53
4.8.6. Soluble Supports	53
4.8.7. Soluble Interfaces	54
4.8.8. Removing Soluble Supports	54
4.9. Slicing and Exporting	55
4.10. Using Nozzles with Various Diameters	55
5. Material Guide	56
5.1. PLA	56
5.2. PETG	57
5.3. ASA (ABS)	58
5.4. PC (polycarbonate) and PC Blend	59
5.5. PVB	60
5.6. Flexible Materials	61
5.7. PA (Polyamide) / PA11CF	62
6. Regular Maintenance	63
6.1. Flexible Print Sheets	63
6.1.1. Double-Sided TEXTURED Print Sheet	65
6.1.2. Double-Sided SMOOTH Print Sheet	65
6.1.3. Double-Sided SATIN Print Sheet	66
6.1.4. Improving the Adhesion	66
6.2. Keeping the Printer Clean	66
6.3. Linear Rails	66
6.4. Threaded rods	66
6.5. Fans	67
6.6. Extruder Feeding Gear	67
6.7. Extruder is Clogged or Jammed	68
6.8. Cleaning the Nozzle	68
6.9. Troubleshooting Faulty Sensor Readings and Removing Errors	69
6.10. Filament Sensors	69
6.11. Toolchanger Maintenance and Troubleshooting	69
6.12. PTFE Tubes Maintenance	70
6.13. Nozzle Seal Maintenance	70
6.14. Flashing an Unofficial (Unsigned) Firmware:	71
7. FAQ - Frequently Asked Questions and Basic Troubleshooting	72
7.1. Mesh Bed Leveling Fails	72
7.2. Printer Does Not Recognize the Inserted USB Drive	72
7.3. Loose Belts	73
7.4. Homing Failed	73
7.5. Heating Error	73
7.6. Fan Error	74
7.7. Reverting to an Older Firmware	74
7.8. Nozzle Hitting the Sheet / Other Z-axis Issues	74
8. Advanced Hardware Troubleshooting	74
9. Troubleshooting Print Quality Issues	74
10. Original Prusa PDU - Manual	75

Safety symbols and their meaning



Careful: strong magnetic fields



Careful: mechanical parts. Take care to avoid injury to hands when in close proximity to the device with mechanical parts.



Further information regarding function and service can be found in this user (service) manual or online at help.prusa3d.com.



Before any service intervention, it is necessary to first disconnect the 3D printer from the power source and familiarize yourself with the instructions.



Take extra care when handling or touching parts marked with this symbol, and avoid further risks specified by specific symbols, such as hot surface hazards — burns may occur.



Hot surface! The marked object may be hot and extra care should be taken when touching it.



Unprotected moving mechanical parts can cause injuries, please take extra care.



Do not print directly on this surface.



High electrical currents are being switched on and off in the immediate proximity of parts marked like this. Persons with an implanted cardiac stimulator or other devices for controlling and regulating heart functions must take extra care and consult their doctor before using the 3D printer.



This device is composed of components that must be disposed of in accordance with the Directive on Waste Electrical and Electronic Equipment.



Product Information

Name:	Original Prusa XL
Manufacturer:	Prusa Research a.s., Partyzánská 188/7a, Holešovice, 170 00 Prague 7, Czech Republic
Contacts:	Phone: +420 222 263 718, e-mail: info@prusa3d.com
EEE category:	3 (IT / Telecommunications Equipment), device usage: indoor use only
Power supply:	100-240 VAC, 10 A max., 50-60 Hz
Frequency band:	2400.0-2483.5 MHz
Maximum radio-frequency output power:	< 100 mW e.i.r.p.
WLAN standard:	IEEE 802.11 b/g/n
Operating temperature range:	18 °C (PLA)-38 °C
Maximum air humidity:	85%, non-condensing
Printer dimensions:	Width (incl. Wi-Fi antenna and filament side sensor): 580 mm
	Depth: 700 mm
	Height (incl. cables to extruder): 910 mm
Installed nozzle diameter:	0.4 mm
Weight (with packaging / without packaging):	35.0 kg max. / 25.3 kg max. (without filament)

The product serial number can be found on the type label located on the back of the printer and on the outer packaging.

This device is intended for use in indoor environments only where it is protected against external influences.

Operating conditions according to CEPT/ERC/REC 70-03

Simplified Declaration of Conformity

Manufacturer Prusa Research a.s. hereby declares that the product Original Prusa XL is in compliance with Directive 2014/53/EU applicable in the European Union and the Statutory Instruments 2017 No. 1206 applicable in the United Kingdom.

The full text of the Declaration of Conformity is available at: prusa.io/xl-documents.

Warranty

The Original Prusa XL 3D printer is covered by a 24-month warranty for end customers in the EU, and a 12-month warranty for business customers and end customers in the rest of the world. Consumables and parts subject to wear and tear are excluded from this warranty.

The warranty period starts on the day the customer receives the goods. The seller is not liable for any damage caused by improper handling of the purchased product, or damage caused by handling in violation of the information and recommendations given in the official manuals and instructions. The warranty also expires in the event of unskilled interventions and the use of unofficial hardware and software modifications.

Safety Instructions and Disclaimer

Acting in contravention of the information provided in the manual may lead to injury, poor print results, or damage to the 3D printer. Make sure that everyone working with the printer is familiarized with the content of this handbook and understands it correctly. As we cannot control the conditions under which the Original Prusa XL printer is assembled, we do not assume any responsibility and expressly disclaim any liability for losses, injuries, damages or expenses arising out of or in connection with the assembly, handling, storage, use or disposal of the product. The information in this manual is provided without any warranties, expressed or implied.

Be very careful when handling the 3D printer. It is an electrical device with moving and heated parts.

Placement and Basic Use

- Make sure that the printer is located and operated in a safe place to avoid potential risks.
- This device is intended for indoor use only. Do not expose the device to water or snow. Contact with water and other liquids may lead to damage to the electronics, short circuits, and other types of damage. Always operate the printer in a dry environment.
- Place the printer in a safe dry place on a horizontal and stable surface - e.g., a work table. Around the printer should be at least 30 cm of space. If there are obstacles close to the printer, it may affect its operation or cause excessive wear of the textile cable sleeves or even the cables themselves. Worn cables can pose a risk (electric shock, fire).
- Make sure that none of the exhausts/fans is blocked. The printer has a built-in fan speed monitoring, but in some cases (incorrect assembly, damage to components, unofficial firmware) the monitoring may not work correctly. Insufficient cooling can lead to overheating and serious damage to the printer (risk of damage to electronics, fire).
- Make sure that the printer is placed so that it cannot be toppled over or dropped to the ground. If the printer has suffered physical damage, do not use it - damaged parts of the printer may pose a safety risk.
- The power cable must be placed so that it cannot be tripped over, stepped on, or otherwise damaged. Place it on a stable, solid surface (e.g., a work desk). If the printer is damaged, stop using the device, turn it off immediately and replace the cable. Damaged cables pose a safety risk - there is a risk of electric shock or fire.
- Do not leave the printer switched on without supervision! The printer has temperature monitoring and a number of smart features for increased safety, but in the case of use contrary to the instructions in this manual or failure of components, there is a risk of fire.
- Never place anything into the printer under the heatbed - the heatbed is a moving part and could crash into objects underneath it!

Electrical Safety

- The printer should only be powered through a standard 230 VAC, 50 Hz or 110 VAC, 60 Hz outlet. Never use alternative power sources as they can cause problems or damage the printer.
- Do not use the printer if the power cord is damaged in any way – damaged cords can lead to electric shock.
- When disconnecting the power cord from the outlet, pull the plug, not the cord, to reduce the risk of damaging the plug or outlet.
- Never disassemble the power source of the printer as it contains no parts that can be repaired by an untrained worker. Always take the printer to a qualified service technician for repairs. Improper interventions in the power source may lead to damage to the printer and an increased risk of electric shock.
- The device is disconnected from the power supply by pulling out the plug. The electrical outlet must be easily accessible.
- Never, under any circumstances, disconnect electrical parts when the Original Prusa XL is turned on - this includes, but is not limited to, disconnecting the Nextruder or other tool heads from the mainboard; disconnecting heatbed tiles; disconnecting the LCD and more. Always turn off the printer before disconnecting electrical parts.

The printer is equipped with a replaceable fuse located in the fuse holder near the connecting connector of the power source and it protects the entire printer. Before replacing the fuse, switch off the printer and disconnect the power supply by pulling out the power cord from the outlet. Push the fuse holder out using a flat screwdriver, remove the fuse and insert a new one. Push the fuse holder back in place. Always make sure the new fuse has the same value as stated on the label (F10AH/250V). If the fuse blows repeatedly, contact the service.

Mechanical Risk

Moving mechanical parts of the printer can cause injury.

- Never interfere with the inner components of the printer when it is connected to the power supply or running – there is a risk of injury from mechanical parts or electric shock.
- Prevent children from manipulating the printer without the supervision of an adult – even when the printer is not printing.

Burn Risk

- Do not touch heated parts of the printer – heatbed, print plate, and parts of the printhead. There is a risk of burns.
- Warning! During printing, parts of the printhead and the print plate can heat up to very high temperatures! Do not touch them until the printing ends and the printer cools down – otherwise, you may get burned.

Proper Use of Double-Sided Print Sheets

Each type of print sheet requires slightly different maintenance. Improper handling and use can lead to damage to the print sheet, heatbed or other parts of the printer. Print sheets are consumable and subject to wear.



The surface of the textured and satin print sheet must not be cleaned with acetone!

- Please refer to the **Flexible Print Sheets chapter** for maintenance instructions.
- To degrease the sheet's surface, use highly concentrated isopropyl alcohol (90% or higher).
- Do not use products that contain IPA as one of the components (e.g. hand sanitizers) - these products usually contain other additives that may negatively affect the properties of the printing plate.
- Do not wash under running water - the sheet may start to rust.
- Do not remove the PEI film from the plate surface.
- Before printing, clean the sheet's surface with an isopropyl alcohol-dampened wipe.
- Printing sheets are held in place on the heated bed with strong magnets - be careful when placing the sheet on the heatbed to avoid injury.
- Do not slide the sheet when it is attached to the heatbed with magnets - the friction may lead to damaging the heatbed.

Working with Filaments

When handled correctly, working with filaments is straightforward and safe. Please read the following recommendations.

- Always use the recommended temperatures for the selected material.
- Beware of molten plastic - it can cause burns! If there is molten plastic stuck in the nozzle, do not remove it by hand - use pliers or other tools.
- Some materials may emit a strong odor when printing - regularly ventilate the room.
- Handle the filament according to the instructions on the following pages of the manual.
- Always make sure that the end of the filament is properly secured (either in the extruder or in the spool). If you accidentally release the end of the filament, it may easily tangle up and create knots.

1. Introduction

Thank you for purchasing the Original Prusa XL 3D printer from Prusa Research! Your support allows us to invest in further development of 3D printers and other 3D printing products. The Original Prusa XL is a great option for beginners, hobbyists, companies, and even for setting up a 3D printing farm.

Please note that this handbook covers all available Original Prusa XL models - assembled and semi-assembled models, as well as single-tool and multi-tool models. Photos included in this handbook may sometime depict a printer model slightly different from yours. However, unless the text states otherwise, the instructions are applicable to all XL printers, no matter what is depicted in the photo. For example, the photos in the chapter explaining how the filament is loaded depict a single-tool machine. However, the same process works for multi-tool versions as well.



i The latest version of this handbook can be found at prusa3d.com/drivers in PDF format.

If you encounter any problems while using the printer, do not hesitate to contact us at info@prusa3d.com. We will be happy to answer your questions or hear your ideas for improvement. You can also visit our Knowledge Base at help.prusa3d.com or the user discussion forums at forum.prusa3d.com.

2. Original Prusa XL Overview and Glossary

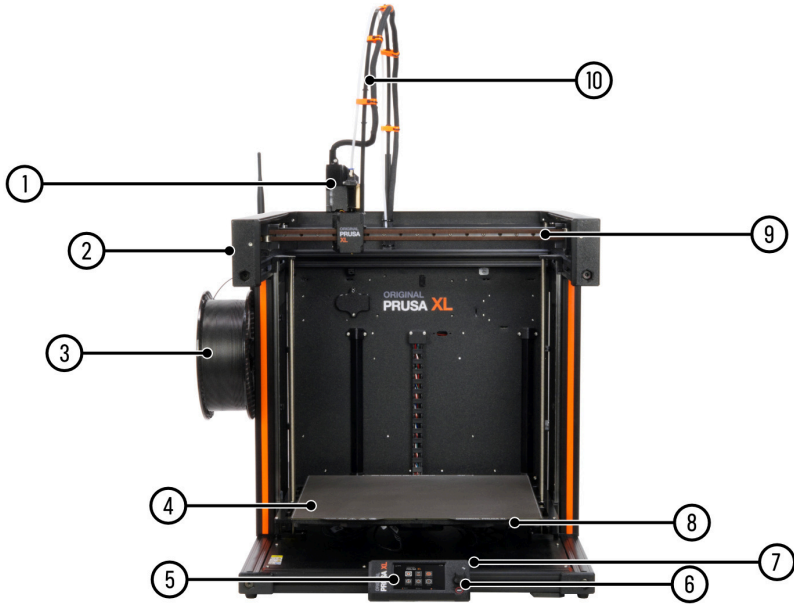

Original Prusa XL Single-Tool Version

1. Extruder (Nextruder)
2. Filament sensor / Filament insertion point (on the side)
3. Spoolholder (with a spool installed)
4. Print sheet
5. LCD
6. Control Knob and Reset Button
7. USB port
8. Heatbed (moves along the Z-Axis)
9. X/Y axis
10. Extruder cables and PTFE tube

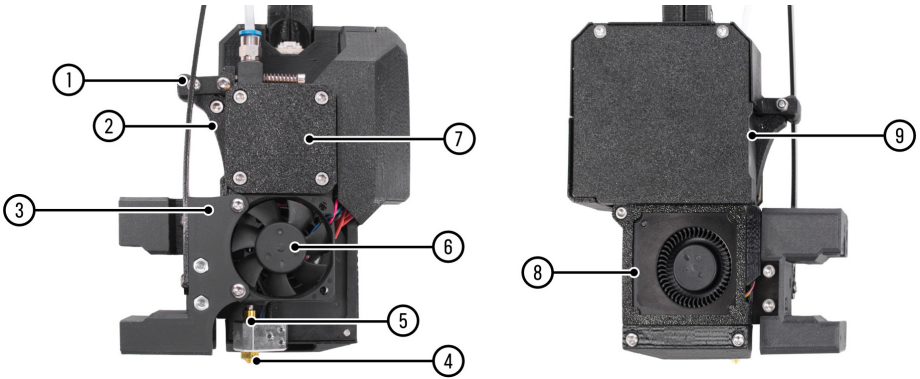

Nextruder - Single-Tool Version

1. Idler locking mechanism (swivel)
2. Idler
3. Nextruder body
4. 0.4mm nozzle
5. Heater Block (part of the Hotend assembly)
6. Heatsink Fan
7. Gearbox and extruder motor
8. Print fan
9. Control buttons (extrude / retract filament - works only when the nozzle is preheated)



The difference between the single-tool and multi-tool Nextruder

There is a slight difference between the single-tool and multi-tool Nextruder versions. While the body is largely unchanged, the front side of the Nextruder is different - the multi-tool Nextruder features a special locking mechanism for the toolchanger. This is why it is not possible to freely swap single-tool and multi-tool Nextruders. See the next pages for more details.

Original Prusa XL Multi-Tool Version (2-5 toolheads)

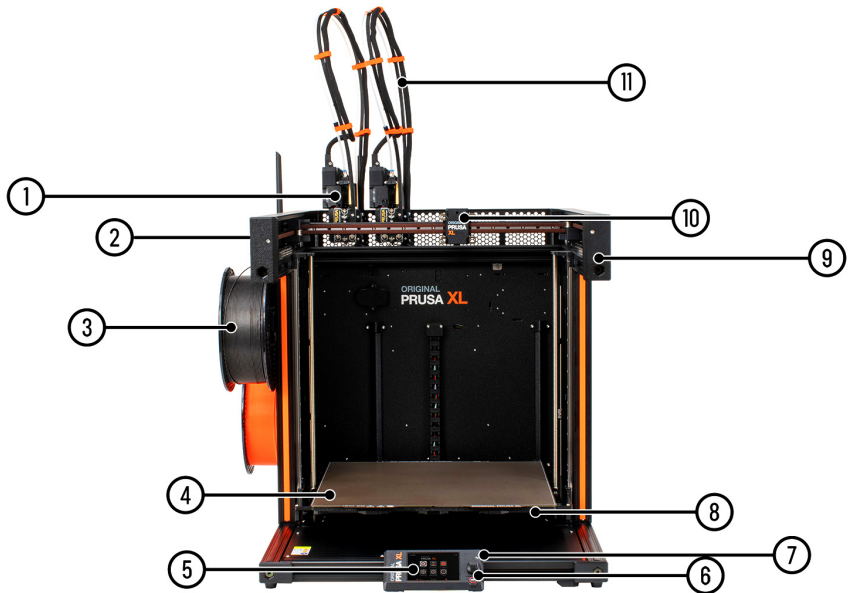

1. Extruder (Nextruder)
2. Filament sensors and Wi-Fi antenna (on the side)
3. Spoolholder (with a spool installed)
4. Print sheet
5. LCD
6. Control Knob and Reset
7. USB port
8. Heatbed (moves along the Z-Axis)
9. X/Y Axis
10. Toolchanger
11. Extruder cables and PTFE tube



The Original Prusa XL depicted in this photo is the Dual-Head version. It is identical in terms of operation with the Five-Head version. The only difference is the number of extruders, filament sensors and spoolholders.

Nextruder - Multi-Tool Version

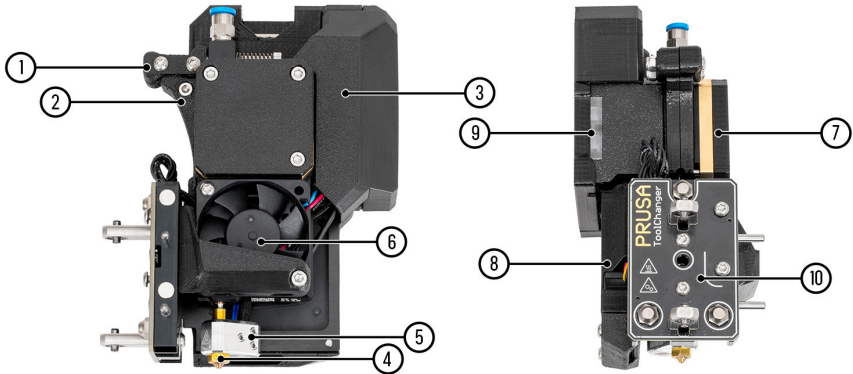

1. Idler locking mechanism (swivel)
2. Idler door
3. Nextruder body
4. 0.4mm nozzle
5. Heater block (part of the Hotend assembly)
6. Heatsink fan
7. Gearbox and extruder motor
8. Print fan (on the side)
9. Control buttons (extrude / retract filament - works only when the nozzle is preheated)
10. Toolchanger connector



How to lock and unlock the Nextruder manually

The toolchanger is purely mechanical and does not feature an electronic lock. The selected tool is locked into place by two metal brackets. If you need to unlock the tool from the toolchanger manually (e.g., for troubleshooting), simply hold the toolhead with your hand and use your other hand to slide both bracket to the side. This unlocks the toolhead from the toolchanger.

2.1. Contents of the Package and Accessories

Your Original Prusa XL printer package includes:

- USB drive with sample prints (G-codes)
- XL Tools
- Silicone sock for the nozzle (see help.prusa3d.com for installation instructions)
- Alcohol-saturated wipes, acupuncture needle
- Double-sided Satin Print Sheet
- 1 kg spool of Prusament filament

These are the basic tools necessary for assembly and basic maintenance. We recommend purchasing a few extra accessories, such as: cutting pliers (for cutting the end of filament), isopropyl alcohol, paper wipes, and a plastic spatula (for removing plastic from the print sheet).



The Original Prusa XL comes with a 0.4mm nozzle preinstalled. This nozzle diameter offers a great level of detail and good speed. You can easily replace the nozzle with a different diameter model, or use an adapter and choose any V6-compatible nozzle (available in our e-shop at prusa3d.com)

2.2. How to Move the Printer

If you want to move the Original Prusa XL printer, use the recommended method - **pick up the printer using the integrated holders on the sides**. Due to the weight of the printer, **we recommend moving it with the help of a second person**. Never lift the printer by the cables, filament holders, and profiles on the Y-axis or the X-axis.



2.3. Disconnecting the Power Source



Always pull the connector, do not pull on the cable itself! Incorrect handling can lead to damage to the connector or cable.

If you encounter any issues with your 3D printer, we recommend first going through the last chapters of this manual, general print troubleshooting guides or visiting our Knowledge Base at help.prusa3d.com. If you cannot find a solution to your problem, contact our customer support via email at info@prusa3d.com or via chat at prusa3d.com - the Live Chat window is located in the bottom right corner.



2.4. Error Screens

If the printer encounters a critical error, **an error screen will be displayed with a description of the error.** The information on the screen is intended to facilitate easy identification, diagnosis and resolution of the error. **Pay special attention to the text on the screen.** Most error messages are supplemented with a QR code - scanning them (e.g. using a camera on a mobile phone) will take you to a relevant article with instructions on how to proceed.

3. Your First Print

To get your printer up and running, please pay attention to the information in the following chapters. We will go through the basics together - you'll be printing in no time!

In this chapter you will learn how to:

- Control the printer
- Prepare the print sheet for the first print
- Perform initial calibration
- Insert filament
- Start the first print
- Remove the print
- Troubleshoot basic issues
- Update the firmware

3.1. Basic controls

All configuration steps and overall control of the printer are done with one control element - a rotary knob. **Rotate it to select items on the screen and press it to confirm your selection.**

The reset button is located under the rotary knob. Pressing the reset button is the same as quickly turning the printer off and on again. It is useful in cases where it is necessary to immediately stop an action that the printer is currently performing.



3.2. Initial One-Time Calibration (Selftest)

When you first power on the Original Prusa XL, the Selftest calibration wizard will start. **The wizard will walk you through the initial calibration and all necessary tests to start printing.** Completing the entire checklist is mandatory. But don't worry, it's gonna be super easy, barely an inconvenience!



The Selftest is designed to run a basic check of the entire machine and determine whether the assembled printer arrived in good shape or whether you assembled the kit correctly. It is a one-time process that does not need to be repeated before every print. Run it again only in case the printer doesn't operate correctly.

The Wizard will provide you with text descriptions and illustrations of the individual steps. For clarity, some actions are further described in the following lines.

You can also start the Wizard manually using the *LCD menu - Calibration*. The Wizard will require you to install a print sheet - we will look at the correct handling in the next chapter. A comprehensive explanation of print sheets and proper maintenance along with an explanation of which ones are suitable for which purpose can be found in the **Regular Maintenance chapter**.

Multi-Tool Differences

The Original Prusa XL will automatically recognize the number of installed tools and add more items to the Selftest - namely Dock Offset Calibration and Tool Offset Calibration in case you have more than one tool installed.

Depending on your printer configuration, the Selftest and calibration may take between 10-25 minutes.

Let's place the print sheet onto the heatbed now. We'll explain the correct process in the next chapter.

3.3. Preparing Flexible Print Sheets



Make sure there are no obstacles or objects under the heated bed, otherwise, the heatbed could crash into them when moving down.



Do not drag the print sheet across the heatbed, especially when it is attached with magnets - you might damage the heatbed.

The Original Prusa XL comes standard with a double-sided satin print sheet. If you have a different type, we recommend that you **carefully study how to properly treat the surface** in the **Regular Maintenance** chapter.

How to install a print sheet correctly:

There are high-temperature magnets embedded into the heatbed that hold the removable flexible print sheets in place. On the back of the heatbed, you will find two pins that fit exactly into the cutout of the print sheet. **Before installing the sheet onto the heatbed, make sure that it is perfectly clean. Never print directly on the heated bed!**



Attach the sheet by first aligning the rear cutout with the locking pins on the back of the heated bed. (marked in orange in the picture above). Hold the sheet by the front two cutouts and slowly lay it down onto the heated bed - **watch your fingers!**



! Important: It is absolutely essential that the print sheet is properly attached to and aligned with the heatbed - the cutout must match with the two pins on the rear and the bed must not be skewed, otherwise there is a risk that the sheet will hit the end stops of the Z-axis and the printer will display an error.

Before you proceed, open the packet containing the cleaning wipes soaked with isopropyl alcohol and wipe the print bed with it.

3.4. Running the Selftest



During the Printer Selftest, do not manipulate with the printer unless the wizard asks you to. If the printer is placed on an unstable surface or if there is another running 3D printer next to it, it may affect the accuracy of the calibration. The printer should be placed on a stable surface.

For the Selftest and the filament sensor calibration, **you will need at least 130 cm (4.5 ft.) of filament.**

The Selftest is a set of **various tests that serve as a diagnostic tool.** With their help, you can detect the most common problems, such as **incorrect wiring of cables.** The progress and results of each test will be displayed on the LCD. If the Selftest detects an error, the testing will be interrupted and the cause of the error will be displayed on the screen.

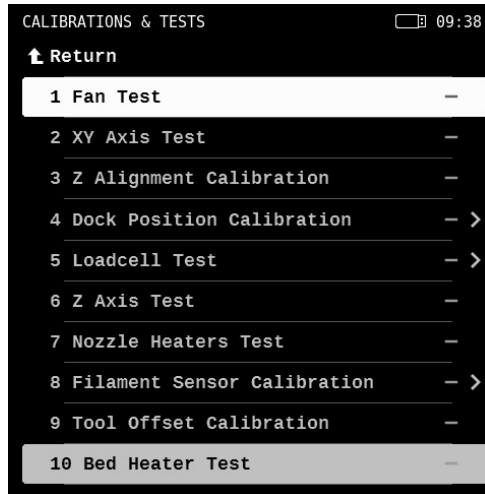

The Selftest includes:

- Test of the extruder and the print fan
- Test of the X, Y, and Z axis
- Proper connection of the heated bed and the hotend
- Loadcell test
- Dock Offset Calibration (only when you have more than one toolhead)
- Tool Offset Calibration (only when you have more than one toolhead)
- Setting up the filament sensor - how to correctly insert filament is described in the following chapter.

A majority of all tests are fully automatic and don't require any user interaction. However, there are a few exceptions. Let's look at them in the following chapters.

3.5. Dock and Tool Offset Calibration (Multi-Tool printers only)

If you have 2-5 toolheads, the printer will automatically detect them and require you to perform offset calibrations. Everything is described in detail on the screen of the printer. Simply follow the instructions and check the illustrations to finish the calibration. The procedure takes roughly 3 minutes per toolhead.

When performing the dock offset calibration, **make sure you're using the proper tools**. Be careful when removing the docking pins - do not drop them inside the printer. If you have trouble with any of the steps during this calibration, **please refer to the online guide** at help.prusa3d.com.

When the Selftest proceeds to the **Tool Offset Calibration**, make sure to follow the on-screen instructions. There is a **slot for storing the calibration pin** in the filament sensor on the left side of the printer - when not in use, **store the calibration pin in this slot**. Once the printer asks you to install the calibration pin, remove the print sheet and locate a large hole directly in the middle of the heatbed. Insert the threaded part into the hole and screw it in. **Do not use excessive force** to tighten it.

Let the printer calibrate each tool individually. Once everything is calibrated, the Selftest will proceed to the next step - filament sensor calibration.

3.6. Filament Sensor Calibration

For the Filament Sensor Calibration, you will need at least 130 cm (4.3 ft.) of filament. We recommend using a standard spool of filament and simply feeding the material in, you don't have to cut a precisely measured strand of plastic to perform the calibration.

1. Take a spool of filament and place it on a spoolholder on the left side of the printer
2. Carefully unhook the end of the filament - do not let it go or the filament could tangle up
3. Use sharp pliers to cut the end of the filament into a sharp point
4. Follow the on-screen instructions and calibrate the XL's filament sensor (sensors). In case you have four or five toolheads, you will need to switch the spool to the right side of the printer where filament insertion points 4 and 5 are located.

This concludes the initial Selftest / Calibration wizard. Now it's time to start printing. Let's continue in the next chapter, where we describe how to correctly load filaments into the printer.

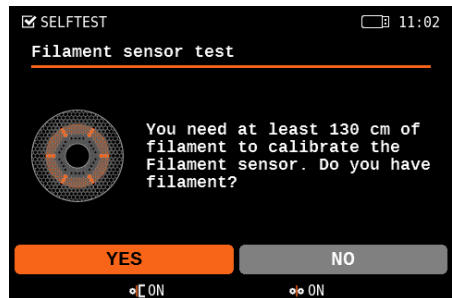
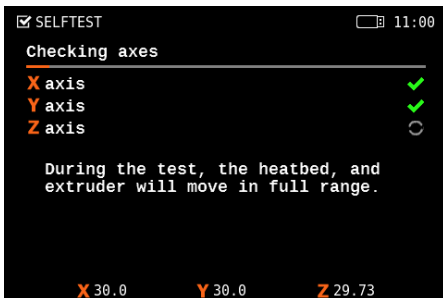

3.7. Inserting filament

If you are starting with the printer, we recommend choosing PLA for the initial print. This material is easy to work with and does not require complex pre-print preparation.

Before you insert the filament, start by placing the filament spool on the side holder. Be careful not to let go of the end of the filament strand - the spool could easily tangle up.

1. **Cut the end of the filament into a sharp point.** Insert the filament into the PTFE tube on the side and keep pushing it inside. If the filament sensor is on, the filament will be automatically fed. If the filament sensor is off, proceed to step 2.
2. Select the *LCD Menu - Filament - Load Filament* and confirm with the button.
3. The Preheat menu will automatically appear. Select the **material of the filament you want to insert** and confirm the selection with the rotary knob.
4. Wait until the nozzle reaches the desired temperature.
5. Press the rotary knob to start feeding the filament. Push the filament into the PTFE tube lightly until you feel that the extruder gear grabbed the filament and is pulling it in.
6. The feed wheel in the extruder will then feed the filament further into the extruder. Once it heats up fully, it will push out a bit of material from the nozzle. **The printer will ask if the color of the extruded filament is okay.** The message on the screen will say: Yes / Purge More / Retry. Check if there is filament extruded from the nozzle, then select:
 - If the filament is extruded and the color is correct, select YES
 - If the filament is not extruded or is contaminated with another color, select: PURGE MORE (you can repeat this step)
 - If the filament is not extruded and PURGE MORE doesn't help, repeat the loading procedure by choosing RETRY

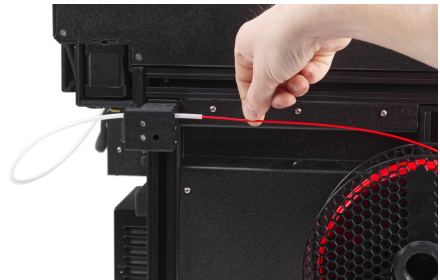
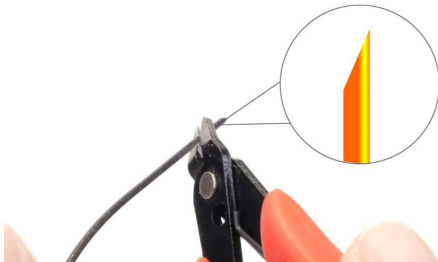

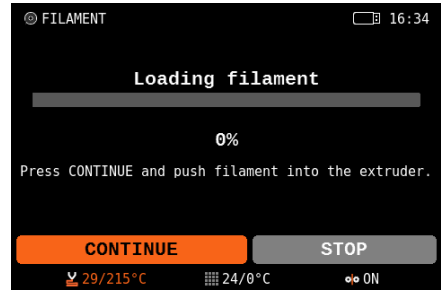

The printer remembers which filament is inserted into it even when you turn it off. The type of filament is displayed in the lower section of the LCD menu.

Loading / Changing multiple filaments at the same time (Multi-Tool only)

If you have an Original Prusa XL 3D printer with a toolchanger (2-5 extruders), you can load or change multiple filaments at the same time. On the left side of the printer, there are filament insertion points 1-3. Filament insertion points 4 and 5 are on the right side of the printer.

Open the Filament menu on the printer's screen and select Change Filament in All Tools. The printer will then display a list of available extruders. Select any of them to choose whether you want to keep the currently loaded filament or load a new one. The printer will then guide you through the rest of the process.

For the next step (Starting the First Print), **leave the filament inserted in the printer**. If for any reason you need to change the filament, the procedure is as follows:

3.8. Removing Filament

1. Select *LCD Menu - Filament - Unload Filament*
2. The printer will preheat automatically depending on the selected material. As soon as it reaches the right temperature, the filament will be unloaded from the extruder in a few seconds.
3. Once the extruder stops unloading the filament, remove it from the PTFE tube by hand. Please keep in mind that the process of unloading the filament strand from the extruder takes a few seconds. Do not pull hard on the filament when the unloading process is running. Check the printer's screen for information.
4. Make sure to secure the unloaded filament when you wind it up back onto the spool. If the end of the filament slips out, the spool may become tangled.

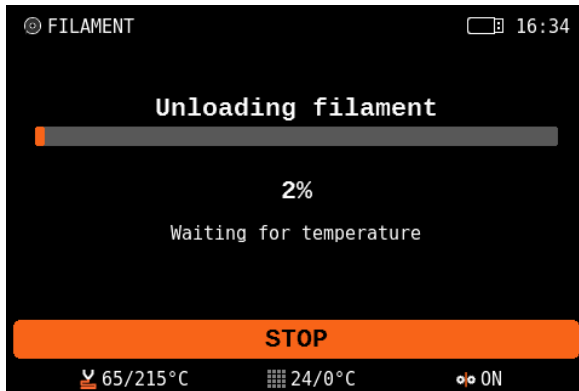

Tangled filament? Let's fix it!

If you accidentally manage to let go of the end of the filament and the strand quickly retracts onto the spool, it's possible that the filament became tangled. This poses a risk during printing - a knot can form on the strand of filament, which will inevitably lead to a failed print. Simply remove the spool from the spoolholder and start unwinding the filament strand from the spool until you find the crossed section. Fix it and wind the filament back onto the spool.

3.9. Starting the First Print

If you haven't done it already, clean the print sheet with the enclosed wipes saturated with isopropyl alcohol and select one of the test objects from the Print menu (only appears if a USB drive is inserted). Confirm the selection with the button. Watch the printer closely during the first print. We recommend **selecting the PRUSA logo or First Layer Test**. These give you the best and fastest overview of whether everything is properly set up.

The nozzle will first preheat to 170 °C independently of the selected filament - the temperature is lower to prevent the filament from dripping from the nozzle. Then, the printer performs **Mesh Bed Leveling** - the nozzle will check the distance to the print sheet in several places to **create a virtual height map of the surface**. This allows the printer to lay down a perfect first layer every time.

Subsequently, the printing of the object or objects will take place.

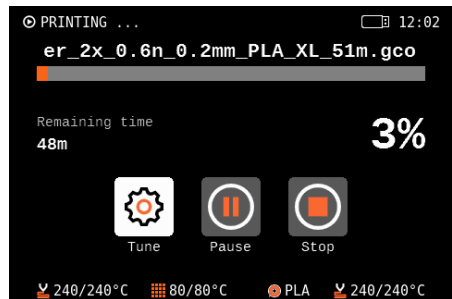
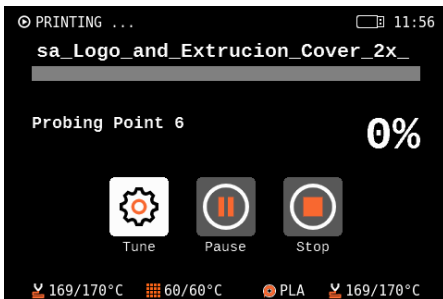

Carefully observe the quality of the first layer. The Original Prusa XL is equipped with very accurate LoadCell technology, which measures the distance between the nozzle and the bed with perfect accuracy. However, it may happen that **due to, e.g., traces of grease, the print may not hold well**. If you find that the plastic is peeling off the bed, **stop the print by selecting the Stop print icon on the screen**. Clean the bed and try again. If the first print fails repeatedly, go to the **First Print Troubleshooting chapter**, where you will find useful tips and tricks.

3.10. Removing a Printed Object from the Print Sheet

Once the printing is finished, wait until the print sheet cools down. The print plate and heated bed may exceed 100 °C, depending on the settings - contact with unprotected skin can cause burns. Check the heatbed temperature in the footer of the LCD screen.

Depending on the type of material, it may happen that the print will separate from the print sheet automatically by itself after cooling. If not, remove the print plate and carefully bend it on both sides. Then turn it by 90° and repeat the bending. **Be sure to remove all pieces of plastic** - don't forget the introductory line on the edge of the plate.



! If there are plastic remnants on the plate, do not remove them with your nails, you could get injured. Use a plastic spatula to remove the remaining plastic.

i Try not to touch the print surface with your fingers - fingerprints are greasy and can reduce adhesion.

3.11. First Print Troubleshooting

The calibration and pre-print setup of the Original Prusa XL are fully automated - the filament is automatically inserted, axes checked and the first layer precisely measured. If a printing issue does occur, it usually falls into one of the following scenarios:

3.11.1. First layer peeling off from the bed

Solution: The most common cause is grease on the bed or an unsuitable combination of material and print surface (e.g. PLA and textured sheet). Make sure that the sheet is sufficiently **degreased using isopropyl alcohol** - more information can be found in the Preparing Flexible Print Sheets chapter. In the Materials chapter, you can find information on how to properly print specific filament types. Water with a bit of dish soap is also an option if you don't have access to IPA - **make sure to clean and dry the sheet thoroughly to prevent rusting.**

3.11.2. Nozzle moves too high/low, or extrudes plastic outside the print area

Solution: Make sure that the print sheet is properly mounted. Due to its size, it may be mounted incorrectly on the heatbed, causing it to hit the end stops of the Z axis (affecting the axis calibration) or it may be shifted outside the print area. **Make sure that nothing is obstructing the movement of the axes** and that all packaging material and transport fixations have been removed from the printer. Run the Auto Home calibration from the menu to test all three axes.



If you built the XL using the assembly kit, double-check that the Nextruder and the heatbed are mounted correctly. Check the wiring of the Nextruder and inspect the Z-axis. Use the Assembly guide as a reference to make sure you built the machine correctly.

3.11.3. The nozzle does not start extruding, even after multiple attempts

Solution: Make sure that the PTFE tube is not blocked and that the filament can freely pass through to the extruder. The filament must have a sharp tip. The extruder has a clamp at its front. Unclamp it and flip the doors open - this will give you access to the feed wheel. Make sure that the filament strand can reach the edge of the feed wheel.

3.11.4. After a few hours of printing, the nozzle stops extruding filament

Solution: Remove the hotend from the extruder (see help.prusa3d.com for exact instructions) and check if the steel filament guide is deformed. This might happen when you overtighten the nozzle assembly.

3.11.5. Individual tools are not picked up or parked correctly

Solution: Please, re-run the **Dock Offset Calibration from the printer's menu**. Dock offset calibration may be incorrect.

3.11.6. Filament is extruded either too high or too low.

Solution: Please, re-run the **Tool Offset Calibration from the printer's menu**. This issue is usually caused by an incorrect tool offset.

3.11.7. The machine produces a rattling sound

Solution: If you built the printer using the assembly kit, it is likely that one of the side panels is not properly secured. Double-check the side panels and the back side (the "backpack") and make sure that all screws are tightly secured.

3.11.8. The filament sensor does not detect filament

Solution: If you built the printer using the assembly kit, it is likely that the filament sensor is disconnected. Check the rear side of the printer and make sure the filament sensor is properly connected to the mainboard.

3.11.9. The printer displays an error related to communication with extruder(s).

Solution: Make sure that the extruders are correctly connected. There are two extruder ports on the mainboard. If the first one is disconnected, the printer won't boot and display an error.

3.11.10. The printer does not turn on

Solution: If you built the printer using the assembly kit, there are multiple areas to check. First of all, check that once you plug the power cord into the power supply unit, the switch next to the plug lights up. If not, the cord may be damaged - you can try a different one. If this does not help, the power supply unit may be faulty. Contact our tech support to resolve this issue. If the switch next to the power cord lights up and the fans spin on startup, but the screen remains black, double-check the wiring of the display using the assembly guide. If the printer is stuck on the loading screen, the firmware installation may be corrupted. See the chapter Updating the firmware and learn how to force a firmware installation.



This problem can be also caused by an incorrectly installed heatbed - especially if there's an electrical short. Turn off the printer, open the electronics box under the heatbed and compare the connection with the photos and instructions in the assembly manual.

3.12. Updating the Firmware

The Original Prusa XL is ready to print once assembled and powered on. To make sure you have the most up-to-date version of the firmware with the latest features and settings, we recommend checking prusa3d.com/drivers. You can perform the firmware update after you perform the initial Selftest.

To check your firmware version, navigate to Info - Version info.

Follow these instructions:

1. Download the correct version of the firmware from prusa3d.com/drivers and unzip the file.
2. Copy the .BBF file to a USB drive formatted with FAT32 - you can use the USB drive that comes with your Original Prusa XL printer.
3. Insert the USB drive into the printer.
4. Restart the device using the reset button (located under the rotary knob).
5. The update process should begin automatically. Confirm flashing by selecting FLASH and pressing the knob.
6. Wait until the process is completed.



To force a firmware installation (e.g. if you need to load an older firmware), insert the USB drive containing the desired .BBF file, restart the printer, wait for the logo to show up and press and hold the control button during the system startup until the firmware installation screen appears.

3.13. Sample Models

The USB drive that came with your Original Prusa XL 3D printer contains a number of sample files (G-codes). We recommend keeping them on the flash drive. These files have been prepared (sliced) and thoroughly tested by us. If you encounter issues with print quality at any time, try loading and printing one of the sample files - especially the Prusa Logo and the First Layer Test. These sample files are designed to test the basic functionality of your Original Prusa XL.

If your print fails and the sample files are printed correctly, it means there's probably an issue with the way your files are sliced. Try reslicing them again with the default PrusaSlicer settings and check for the basic issues:

- Incorrect printer/nozzle profile (the Original Prusa XL is equipped with a 0.4mm nozzle by default)
- Incorrect material settings
- Missing supports
- Incorrectly configured infill
- The model is not in contact with the print sheet

If the sample files are not printed correctly, check the Troubleshooting section, our Knowledge Base at help.prusa3d.com or contact our tech support.

3.14. Factory Reset

If you feel like you changed settings that have negatively affected your 3D printer, you can always revert to factory default values and try again.

Factory Reset can be done via *LCD Menu - Settings - System - Factory Reset*. This will reset all the saved values to their default state.

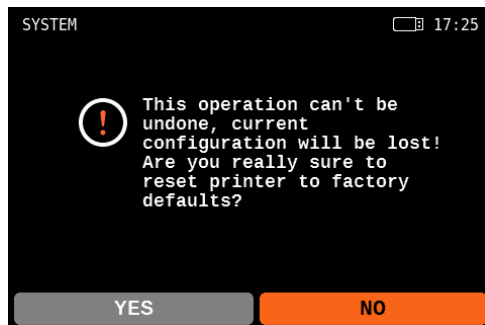

4. Advanced User Guide

This part of the handbook covers everything you need to know once you manage to successfully print your first sample object. Network connection, printing your own models, slicing - all this (and more) is covered on the following pages.

4.1. Prusa Academy Courses

Become an expert in 3D printing! Our Prusa Academy offers **comprehensive online courses on various 3D printing-related topics**. Each course features easy-to-read texts with many pictures and short videos, links for inspiration and further study, quizzes for testing your knowledge, a certificate of completion and more! With our online courses, you can quickly learn how to model your own models and master advanced 3D printing techniques. Visit academy.prusa3d.com to join!

Design Principles for 3D Printed Parts

100% complete

- 1 Getting started
- 2 3D printing limitations
- 3 **Applied design**
 - ✓ 3.1. Vertical holes
 - ✓ 3.2. Sacrificial columns
 - ✓ 3.3. Sacrificial layers
 - ✓ 3.4. Staggered layers
 - ✓ 3.5. Fillets and chamfers
 - ✓ 3.6. Embedding items mid-print
 - ✓ 3.7. Threads
 - ✓ 3.8. Print in place mechanisms
 - 3.9. Compliance and living hinges
 - ✓ 3.10. Splitting model into multiple parts
 - ✓ 3.11. Multiple assembled parts
 - ✓ 3.12. Integrated part strength
 - ✓ 3.13. Quiz: Applied design
- 4 What's next?

Share your feedback

Need help?

Box with a living hinge

The design process is extremely easy, simply extrude a rectangular shape connecting your two objects and extrude it to the desired height.

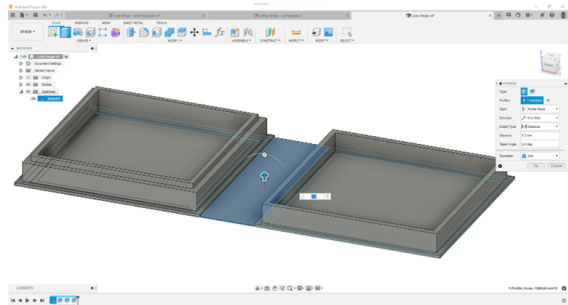

Since the square will connect both the base and the lid, you need to make sure you have enough distance to allow the **hinge to flex without breaking or additional bending stress**. The total height of the **box** once closed, in this case, is 16mm from base to surface:

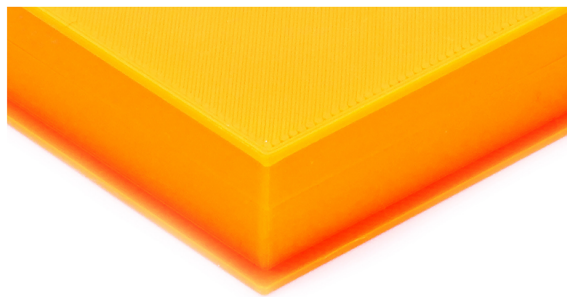

Closed box with a height of 16 mm

4.2. Network Connection

Original Prusa XL has an onboard Ethernet (RJ45) interface and a Wi-Fi module for connecting to the network.

Please be aware that some of the network functions may not be fully implemented in the shipped firmware version. Please check our website prusa3d.com and social media for information on the latest firmware versions.

Original Prusa XL can be connected to a local network (LAN/Wi-Fi), which allows you to have an overview of various functions of the printer through the web interface called PrusaConnect. The printer has DHCP enabled by default. If you need to check if the printer was assigned an IP address correctly, you can check it in *LCD Menu - Settings - Network*.

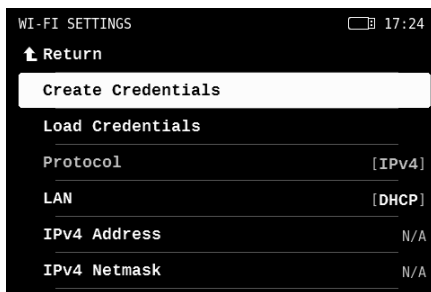

Connect to a wireless network by navigating to the *Network* menu and selecting *Wi-Fi*.

1. Make sure a USB drive is inserted and recognized by the printer.
2. Select the Create Credentials option. This will create a `prusa_printer_settings.ini` file on the USB drive.
3. Remove the USB drive from the printer and insert it into your computer.
4. Open the `prusa_print_settings.ini` file in a text editor.
5. You will see two parameters: `ssid=` and `psk=`. It is necessary to enter your Wi-Fi network information after the "=" sign. For example `ssid=My_Network`, `psk=MyWiFiPassword_1138!`. Use the correct login details for your Wi-Fi network, this name and password are for demonstration only.
6. Save the file.
7. Put the USB drive back into your printer and select Load Credentials. This will upload the Wi-Fi network login information into your printer.
8. You should be connected to Wi-Fi in a couple of seconds.

Subsequently, on a computer or mobile phone connected to the local network, open a web browser and go to connect.prusa3d.com and log in with your Prusa Account. You will be taken to Connect, our web UI for remote printer management.



For more information about connecting to Wi-Fi networks and activating Prusa Connect online features, please check our website help.prusa3d.com.

4.3. Obtaining Printable Models

The easiest way to start with 3D printing is to **download models from the internet** - they are usually in .3mf, .stl or .obj formats. Luckily, there are many enthusiasts in the 3D printing world, so **a large number of 3D models are available for free**. You can download anything from a simple die to detailed figures from your favorite games, movies, and series; mechanical parts, RC accessories, various household items, and even massive complex projects.

Get the best models at Printables.com!

One of the best places for free 3D models is [Printables.com](https://www.printables.com), a large online library **full of high-quality 3D models** managed by Prusa Research. Its main goal is to bring together a large community of designers, creators, and 3D printing enthusiasts - regardless of the brand of 3D printer they prefer. There are **regular community contests with 3D printers and filaments as main prizes**, and there is also a rewards system with virtual and physical goods - simply by being an active member, you can collect points and exchange them for a spool of Prusament or other cool stuff.

Thanks to its focus on high-quality, unique, and useful 3D models, you are only a few clicks away from discovering something new and amazing to print. And before you actually download and print something, you can use the advanced built-in 3D model viewer, which works with STL and 3MF files as well as G-codes. Visit [Printables.com](https://www.printables.com) and discover all kinds of activities, contests, events, groups, collections, and more!

Printables 3D Models Community Contests Brands Events Groups Education Prusa Blog Prusa Eshop [+ Create](#)

Make it fly!
Join our flying contest
End: Friday, March 31st, 23:59 GMT
[CONTEST PAGE](#)

Featured Models

- Wekster**
Rodney McKay
Toys & Games > Action Figures & Statues
❤️ 53 ⭐ 5 📄 94
- Péter Beluzsár**
Portal Button Keycap
Gadgets > Computers
❤️ 217 ⭐ 5 📄 150
- Bootjevaarder**
OHC V60 Ultramax Engine
Hobby & Makers > Automotive
❤️ 474 ⭐ 5 📄 397
- dbrand**
Project Killswitch - Universal Mount
Gadgets > Video Games
❤️ 170 ⭐ 0 📄 161

[EXPLORE MODELS](#)

Models are usually available to download either for free under the Creative Commons - Attribution - Non-Commercial License (models cannot be used commercially and must always include the author's name), or for a small fee. We have selected the most interesting websites for you:

- www.printables.com
- www.thingiverse.com
- www.myminifactory.com
- www.pinshape.com
- www.youmagine.com
- www.shapeways.com
- www.gambody.com



Keep in mind that models in .stl, .obj, etc. formats cannot be printed directly. First, these files need to be "sliced" (prepared for printing), which results in a G-code file. This file contains the actual instructions for the printer. You place the G-code on a USB disk and then insert it into the printer. Then you just start printing. You will find out more in chapters What is a G-code file? and PrusaSlicer.

4.4. Create Your Own Model

To create your own 3D model, you need a special program - a 3D editor. There is a wide range of different programs available, so you can choose the one that best meets your needs.

To get started, the best option is Tinkercad (www.tinkercad.com) - an online editor which runs in your browser window, with no installation required. It is free, intuitive and there are a lot of tutorials available online. Tinkercad is mainly focused on the creation of less detailed and larger (mechanical) parts, ideal for FFF/FDM printing. Your XL will have no problems printing them. Another popular tool is Autodesk Fusion 360 (www.autodesk.com/products/fusion-360) for PC, Mac and iPad. On the web, there is a simple guide available along with a lot of detailed video tutorials, making it an ideal choice for both beginners and professionals. Check out our Prusa Academy for some great beginner tutorials at <http://www.prusaacademy.com/>!

4.5. What is a G-code File?

3D models you have either created or downloaded from the internet need to be converted from their original format (.stl, .obj, .3mf, etc.) into a file containing specific instructions for the printer - the G-code. This is the format that 3D printers can understand. This file contains instructions about the movement of the nozzle, the amount of filament to be extruded, temperature settings, fan speeds and more.

There are dozens of different slicers available, each with its own advantages and disadvantages. We suggest using our PrusaSlicer.

4.6. PrusaSlicer

As the name suggests, PrusaSlicer is our own in-house developed slicer software based on the open-source project Slic3r. PrusaSlicer is an open-source, feature-rich, frequently updated tool that contains everything you need to export the perfect print files for (not only) your Original Prusa XL. The standout features of PrusaSlicer are:

- Clean and simple UI
- Fine-tuned print and material profiles with automatic updates
- Precise print time/feature analysis
- Customizable supports and modifiers
- Built-in shape gallery
- Variable layer height
- Color painting
- Various print settings

Thanks to the strong community and a dedicated team of developers in Prusa Research, PrusaSlicer is **constantly evolving** with new features and improvements based on community feedback. From print quality improvements to reducing print time and minimizing filament usage, even small updates can have a significant impact on your 3D printing experience. Best of all, **PrusaSlicer is completely free for everyone** (it even includes profiles for 3rd party printers) and is frequently considered the best slicer on the market by independent reviewers.

PrusaSlicer comes with a G-code Viewer, a lightweight application, which you can use to quickly preview G-codes from all popular slicers. Its behavior is identical to the preview in PrusaSlicer (the same code is used), however, you can load an external G-code file. We currently parse, and up to some level interpret, G-code from PrusaSlicer, Slic3r, Slic3r PE, CURA, ideaMaker, Simplify3D, Craftware and KISSlicer. PrusaSlicer G-code Viewer is part of the PrusaSlicer installer package. Simply download the latest PrusaSlicer and the standalone G-code Viewer will install together with it automatically.

 The latest stable version is always available at prusaslicer.com. Development alpha/beta versions can be downloaded from github.com/prusa3d/PrusaSlicer - these are unstable builds with the latest features.

4.7. PrusaSlicer Interface Explained

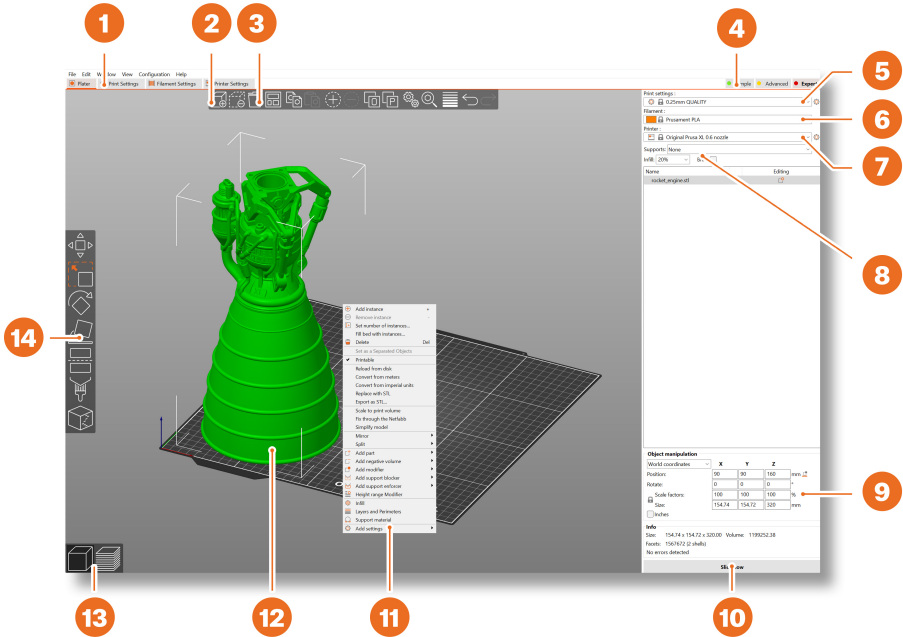

1. Opens detailed Print, Filament and Printer settings
2. Add button to import a 3D model into the scene
3. The Delete and Delete All buttons remove the model(s) from PrusaSlicer
4. Switching between Simple, Advanced and Expert modes
5. Settings for printing speed and quality
6. Material selection
7. Printer selection
8. Quick settings for Infill density, Supports and Brim
9. Information about model size / printing time (after slicing)
10. Slice / Export button
11. Right-click the model to open a context menu
12. Model preview in 3D
13. Switch between 3D editor and Preview mode
14. Move, Scale, Rotate, Cut, Paint-on Supports, Seam Painting tools

4.7.1. Initial Setup and General Workflow

Upon launching PrusaSlicer, select Original Prusa XL from the Printer drop-down menu on the right (no. 7 in the illustration above)

If you don't see the Original Prusa XL in the list, **you need to add it either by using Add Printer-Add Presets menu item** (in the same menu), **or by using Configuration - Configuration Wizard** from the top menu bar. Then select the layer height, infill and the material you intend to use. **If you are not sure about the layer height, stick with 0.20 or 0.25 mm profiles as they give generally good results.**

Recommended infill values are between 5-20 % but it heavily depends on the model and how durable it needs to be. More infill means a more durable model, however, it will take longer to print and more material will be consumed. For general use, there is no point in going above 40% infill, unless your project really requires it.

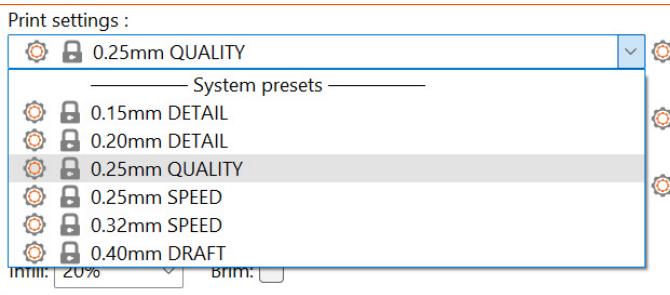

Please note that the default profiles have a tested specific setting for each type of filament. If you choose a different profile, it may affect the print quality negatively.

PrusaSlicer allows you to import objects in STL, OBJ, AMF, STEP and 3MF formats - these are the most common types of 3D files you can find on the internet. You can either drag them directly into the 3D editor window, or use the Add... button from the top bar.

To modify the model, use the tools on the left side bar, i.e. Move, Scale and Rotate. If an object is blue, it means it does not fit into the print bed and it needs to be moved or scaled down. There is no universal way to place the model on the bed, it always depends on the specific shape. However, a general rule is that the bigger the flat surface of the model that touches the bed, the better it will hold - so try to orient the largest flat surface of the model downwards.

4.7.2. Using Supports



Supports are printed structures resembling scaffolding. They are used for printing complex objects. After printing, they can be easily separated from the output.

You can find a large number of objects that can be printed without supports - just place them in the right orientation on the bed, slice them and you can print. **Not all objects, however, can be printed without supports.**

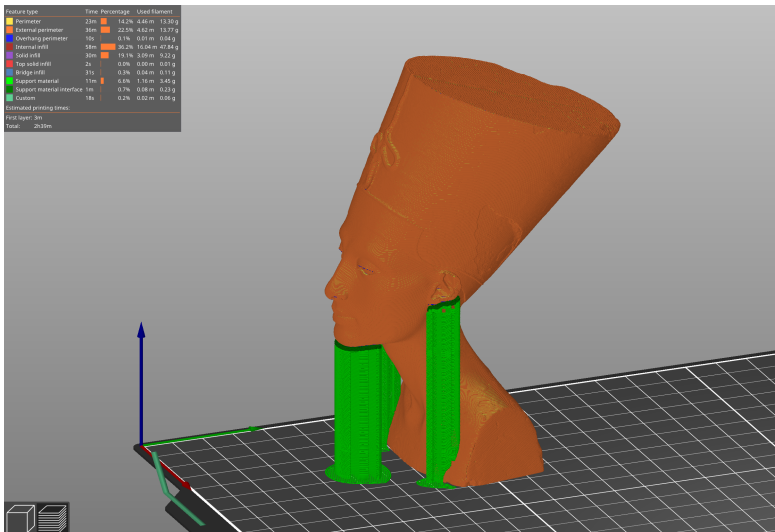

If you are printing an object with walls that rise at an angle less than 45°, these overhangs will cause issues with print quality. **Also, keep in mind that the printer cannot start printing mid-air.** In such cases, supports are necessary.

How to tell whether an object needs supports?

The shortest answer is: it comes with experience. With your first prints, stick to default PrusaSlicer values. Once you feel comfortable with printing complex shapes using default support settings, try playing around with the Overhang threshold option in the settings. We have an extensive list of detailed tutorials available at <https://help.prusa3d.com/category/prusaslicer>

You have three options to choose from when selecting support generation:

- **Support on Build Plate Only** - generates supports only in the space between the object and the print bed
- **For Support Enforcers Only** - generates supports only where enforced by placed modifiers
- **Everywhere** - generates supports everywhere

The default support pattern usually works correctly, but **if you need to modify the places where the supports will be generated**, just go to the **Print Settings** tab and select **Support Material**.

- Check the Generate Support Material box.
- The Overhang Threshold allows you to set the minimum angle for printing the support material. Setting the value to zero will enable an automatic calculation. Try generating supports with different angle settings to see which value works best for your object.
- Enforce Supports is an option mainly used for small models or models with a small base to prevent them from being broken or detached from the print bed during the printing process.
- Wherever the supports touch the model, they are usually associated with a lower surface quality. Try to reduce or even avoid the need for supports by rotating or shifting the model accordingly.

4.7.3. Speed vs Print Quality

A small object can be printed in a few minutes but printing bigger models can take a lot of time - sometimes even dozens of hours. **The printing speed is affected by several factors.** Primarily, it depends on the layer height. This can be set in PrusaSlicer in the **Print Settings** drop-down menu in the upper right corner. 0.20mm DETAIL is pre-set, but you can speed up the printing by choosing 0.32mm SPEED or even 0.40 DRAFT. Models printed like this will have less detail and more visible layers. **If you care more about quality than speed, choose 0.15mm (DETAIL).** The appearance of the models will improve, but at the cost of a **significant decrease in printing speed.**

Some profiles may have two variants.

Quality - slower perimeter and infill printing, improves the surface quality

Speed - faster perimeter and infill printing, without too much impact on the surface quality

The speed can be adjusted during printing, via the *LCD Menu - Tune - Speed*. Then use the knob to adjust the speed up or down. Observe the effect of the speed change on the print quality and choose the settings that suit you best. Remember that this setting does not affect the acceleration of the printer, so the printing time will not be shortened proportionally to the speed setting change.

4.7.4. Infill

Another parameter that affects the properties of the printed object is Infill. It affects the printing speed, strength and appearance of the object.

Objects printed with the FFF/FDM method usually do not have 100% density. Instead, they contain a certain geometric structure inside. It can take various forms, from simple square grids or hexagons to more complex patterns. The purpose of the infill is to stiffen the object from the inside. Most models are printed with 10-15% infill, but if you need a really solid structure, you can choose a higher density.

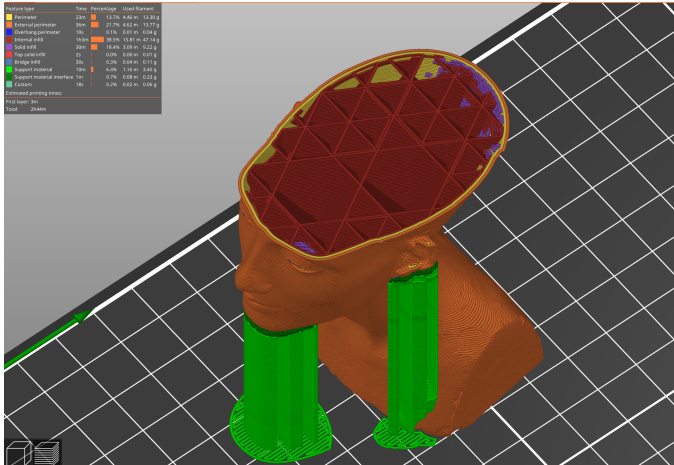

Material	Time	Percentage	Used Material
Infill	22:01	81.2%	46.4 g
Outer shell	0:00	17.7%	4.62 g
Support structure	18:00	21.7%	4.62 g
Support material	16:00	20.5%	2.04 g
Infill	15:00	18.3%	3.87 g
Outer shell	0:00	18.0%	0.22 g
Support material	0:00	0.00 g	0.00 g
Support structure	0:00	0.00 g	0.00 g
Support material	0:00	0.00 g	0.00 g
Support structure	0:00	0.00 g	0.00 g
Support material	0:00	0.00 g	0.00 g
Support structure	0:00	0.00 g	0.00 g

4.7.5. Brim

The brim serves to **increase adhesion to the bed**, reducing the risk of warping. A wider first layer is printed around the model. This makes sense especially if the model only touches the bed in a small area. This function can be enabled in PrusaSlicer by checking the "Brim" box in the menu in the right column. After the printing is finished, **the brim can usually be removed easily by hand**, or you can use a knife or scalpel.

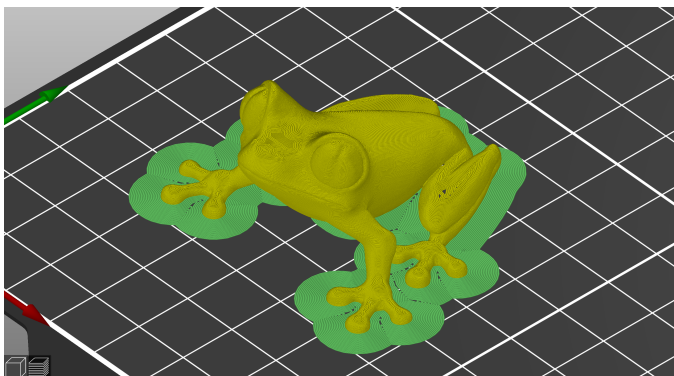

4.7.6. Printing Objects Larger than the Print Volume

The Original Prusa XL printer has a huge print volume of 360 x 360 x 360 mm. If even this is not enough, you can play around with settings to be able to print truly gigantic models. Don't let the size of the print bed be a limitation – at blog.prusa3d.com you can find tips on how to assemble large models from several smaller parts.

Of course, you can also resize the imported model to fit the bed. The Scale tool is there to help you with that.

If you want to print an object which is too large in its original size for the print bed, **you can cut it into several smaller parts**. Use the **Cut tool** from the left menu (or press the letter C). Either place the cutting plane manually or set an exact height using the Cut tool dialog. Choose whether you want to keep only the part above the cut, below it, or both.

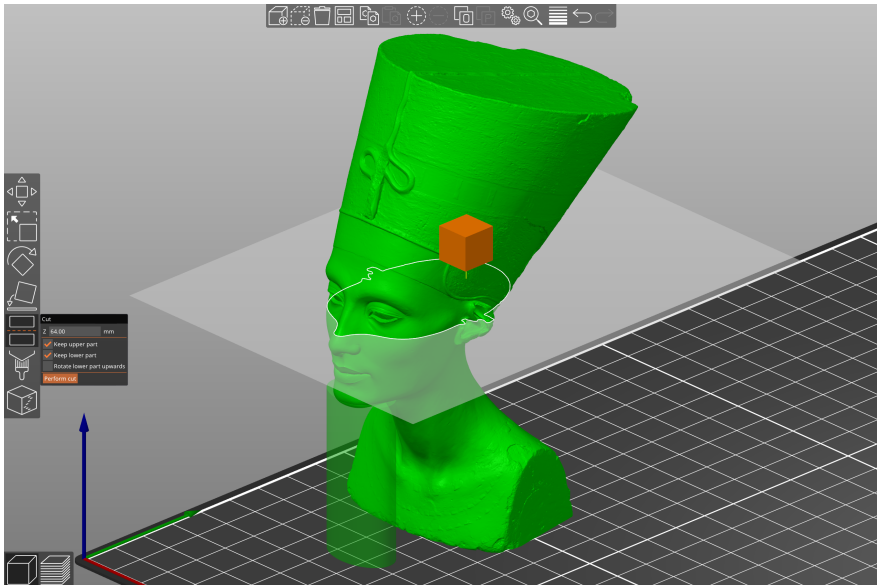

4.7.7. Printing Multicolored Objects (Single-Tool XL)

If you want to have a print with layers in different colors, it can be easily set up directly in PrusaSlicer - follow the instructions below.

1. Switch to the layer view (Preview) using the button in the left bottom corner
2. Use the slider on the right to select the layer in which you want to change the color
3. Click on the orange icon with the plus sign
4. An immediate preview will appear. You can undo the color change by clicking on the gray cross which will appear instead of the orange plus sign
5. Export the G-code and you can start printing!

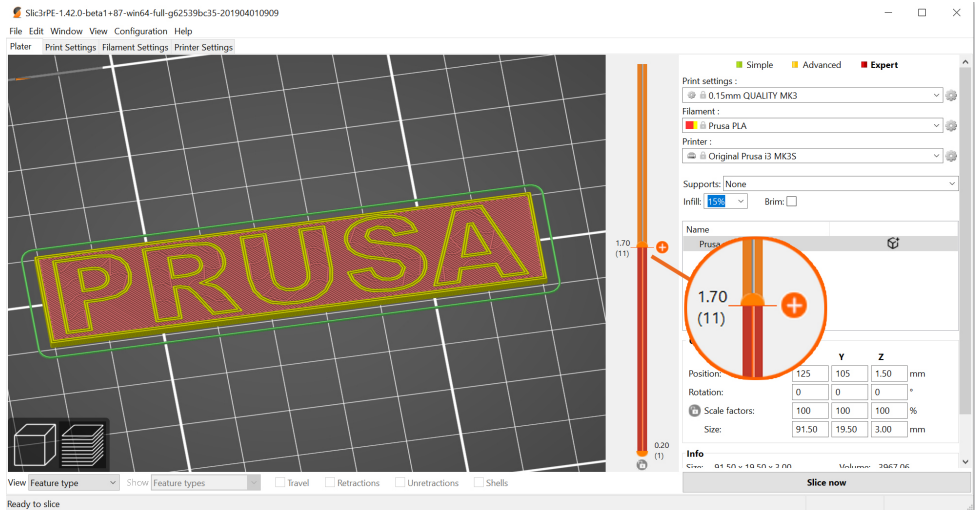

Once the printer reaches the layer, where the color change should happen, **the printer will pause and display a prompt on the screen.** Follow the instructions on the screen to finish the filament change.

4.8. Printing in Multi-Material Mode

The Original Prusa XL enables you to install up to five extruders and load up to five materials at the same time. This is a great way to explore new areas of 3D printing. You can either print multi-colored objects, or you can combine two or more materials. Keep in mind that not all materials bind together well.

The best options are, e.g. using PLA to print supports for expensive materials, such as PCCF and others - so you won't waste precious material on supports. Or you can combine PLA or PETG with soluble materials, such as PVA or BVOH. Once the object is printed, you can submerge it in water and wait until the supports dissolve.

 Keep in mind that not all materials can be easily combined! Certain materials won't bind together well.

4.8.1. Importing Objects into PrusaSlicer

Objects ready for multi-material printing come in three file formats

1. **.3MF and .AMF** - preferred formats that include all of the parts in a single file
2. **.STL** - several separate files, each file for a different part of the object

3MF files are automatically loaded with all the parts already aligned. To load a multi-part model saved as multiple STLs simply drag and drop all of the files inside PrusaSlicer's window and confirm multi-part object auto-detection.

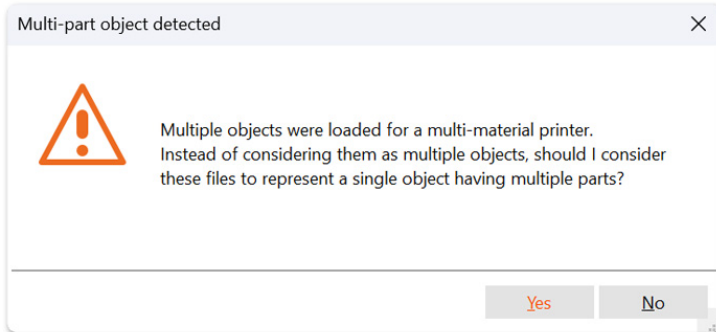

You can see a correctly imported multi-material object in the picture below. (Garfield model by reddadsteve at [printables.com](https://www.printables.com))

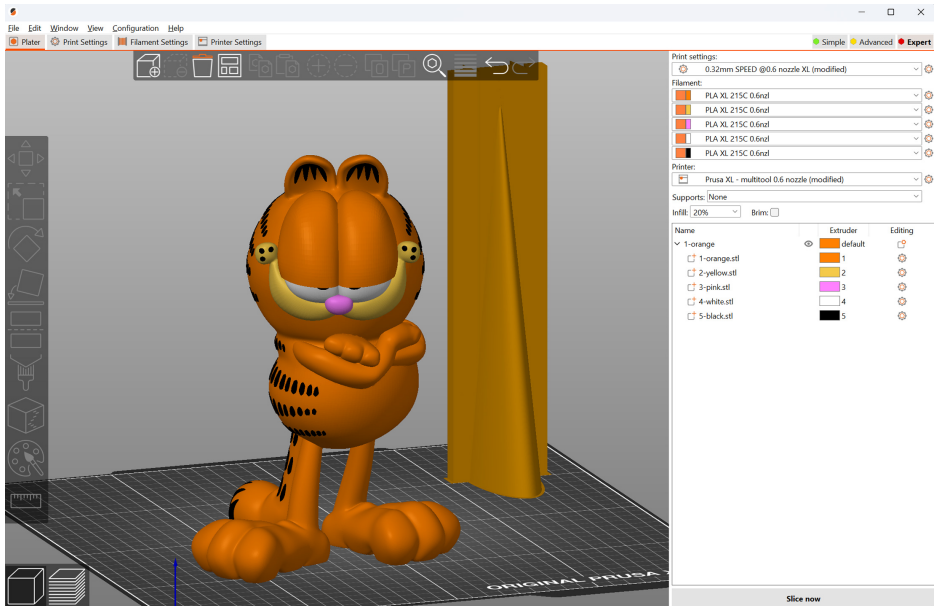

The orange object in the back of the print area is a priming tower (sometimes called a wipe tower). It is used to stabilize the pressure inside the nozzle.

It's important to keep in mind that the printer cannot detect the color of inserted material. This is why it's usually not possible to simply import a 3MF or STL files and start printing right away. It's important to set up the correct materials, colors and extruders before.

We'll cover the entire setup on the following pages.

4.8.2. Setting up Colors

In PrusaSlicer, you can assign materials to specific extruders, and specific extruders to individual model parts. We'll take it step by step.

First of all, **make sure you have Original Prusa XL - Multitool selected** as your printer. Only then you will see the list of up to five filaments.

The extruders are numbered from 1 to 5, starting from the left (when you're viewing the XL from the front). If you have only two extruders, then they are 1 and 2.

When you are loading filaments into your printer, **check the filament sensor boxes** on the sides of the printer - they are clearly marked with the corresponding extruder number.

Now, let's take a look at the right side of the picture below. It depicts the PrusaSlicer interface, where you **select individual filaments and assign them to extruders**. First, focus on the "Filament" section. This is where you should select which filaments you're planning to load into the XL. In our case, all five extruders will have PLA loaded. This section **affects only the type of material** (temperatures and other settings) **it does not affect color!** Small colored rectangles next to filament names are **merely visual indicators!** In other words, even if you have a yellow indicator next to the filament in slot 2, you can load black PLA filament in slot 2 and the XL will print with it.

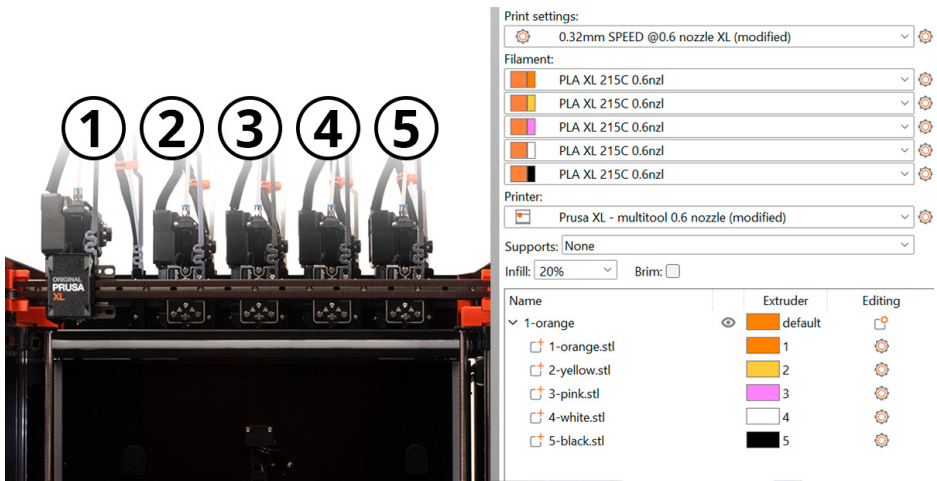

Under the Filament section, there is a list of imported objects. This is where you **assign individual extruders to parts of the model**. Let's say you have orange PLA filament loaded in extruder number 1. And you want to print a specific part of the model with orange color. Simply assign the extruder to desired model part by **clicking the number in the Extruder column** and choosing the corresponding color. Many downloaded 3MF models already have the extruders correctly assigned.

If you want to match the colors of filaments that are physically loaded in your Original Prusa XL with the colors in PrusaSlicer, you can do so by clicking the **small colored rectangle** next to the filament's name. Again, **this is only a visual cue** and does not affect the print in any way.

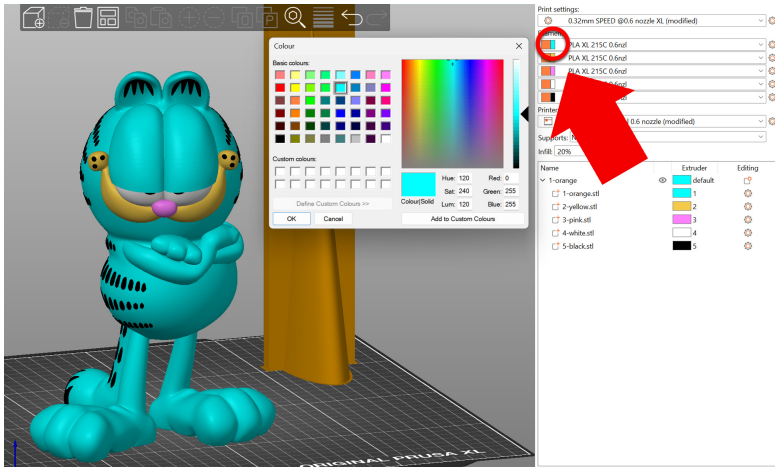

Always make sure that the filaments loaded correspond to filaments selected in PrusaSlicer - printing with incorrect material settings may lead to various issues.

Sometimes, assigning the right colors may be challenging. When we imported this model, there was no indication in which order we should load filaments into the XL to match the pre-configured extruder assignment. In this case, the best way is to go backward. Start by changing the colors in PrusaSlicer as described in the picture above. Once the model in the preview window looks correct, you can also see in which order you should load individual filaments (colors) into the extruders.

Name	Extruder	Editing
<ul style="list-style-type: none"> ▼ back_ridges.stl Wipe options back_ridges.stl_1 belly.stl_1 body.stl_1 eyes1.stl_1 eyes2.stl_1 eyes3.stl_1 horns.stl_1 nails.stl_1 spines.stl_1 spots_body.stl_1 spots_head.stl_1 tail.stl_1 	<ul style="list-style-type: none"> default 1 2 1 3 1 4 2 3 2 5 5 2 	<ul style="list-style-type: none">

Once we assigned the correct colors in PrusaSlicer, it is now clear that we should load purple filament into extruder number one, and then follow with yellow, white, black and deep purple.

4.8.3. Coloring an Object

Of course, not all objects on the internet are ready for multi-material printing. They are not divided into easily accessible parts. What now? The solution is easy: **PrusaSlicer gives you three powerful options for virtual painting**. You can see a work-in-progress screenshot of PrusaSlicer's paint process directly below. Stormtrooper Helmet is a model by Eastman, available at printables.com.



To paint the model in PrusaSlicer, make sure you have the Original Prusa XL Multi-Tool selected in the Printer selection box, otherwise the tools may not be visible. Then, look at the left menu - there should be now an icon with a brush, called Multi-material painting (shortcut N).

This creates a new modifier for the selected object. Check the object viewer on the right side to make sure that the Multimaterial painting modifier is in place.

Name	Extruder	Editing
stormtrooper-helmet.stl	default	
Multimaterial painting		

It will have the default extruder assigned - this is correct. We will add color changes automatically by painting the colors directly onto the model. Let's do it now.

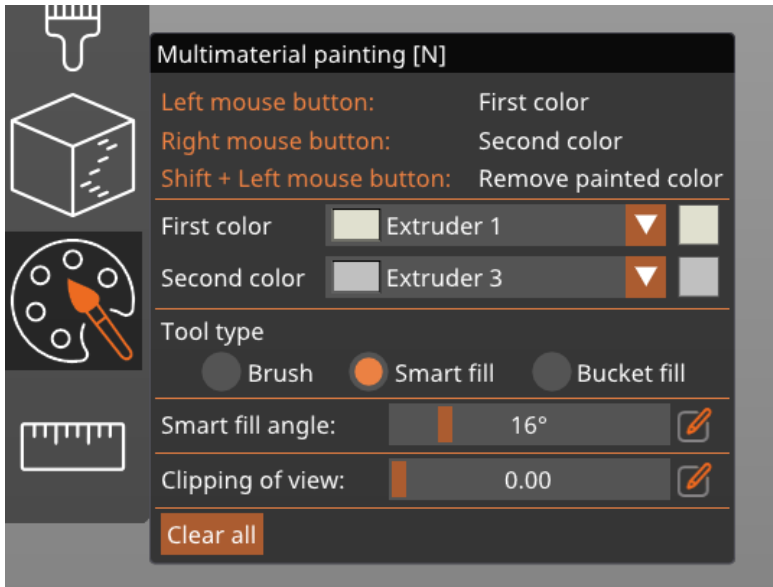

The Multimaterial printing menu is very self-explanatory. You can assign two quick-selection extruders (materials) to the left and right mouse buttons. The First color is set to the left mouse button, the Second color to the right mouse button. Of course, you can change the assigned materials at any time and continue working.

The three main tools are:

Brush: This tool acts as a standard paintbrush. Use the left/right mouse button to paint onto the surface of the object as if you were using a 3D-brush.

Smart fill: The most powerful tool. It can automatically detect entire areas and paint them in the style of a bucket fill tool. The paint fills a region below the mouse cursor up to a sharp edge. To adjust the automatic edge detection, use the angle slider. Lower values limit the area, higher amounts add more tolerance. You can use a combination of ALT+mouse wheel to quickly adjust the value on the fly.

Bucket fill: This tool is used to quickly replace a patch of one color with another.

Please note that thin features are not printable with FDM technology, thus for example painting a thin wall with two distinct colors will not make the thin wall printable. Such thin non-printable regions created during segmentation are thus detected and merged with the neighboring region, changing its color. PrusaSlicer will print thinner features with "detect thin walls" enabled, thus it is advised to try to enable "detect thin walls" if painting over thin features.

4.8.4. Priming Tower

The priming tower (not to be confused with the wipe tower produced by MMU2S/MMU3) is a small, mostly hollow block that is used to stabilize the pressure inside the nozzle once an extruder is unparked from the dock.

The printer extrudes a tiny amount of filament from the nozzle to stabilize the pressure inside the nozzle and then continues to print the main object. As a result, the priming tower is thin and light, resulting in minimal waste. The priming tower is supported with a hollow cone to ensure better stability.

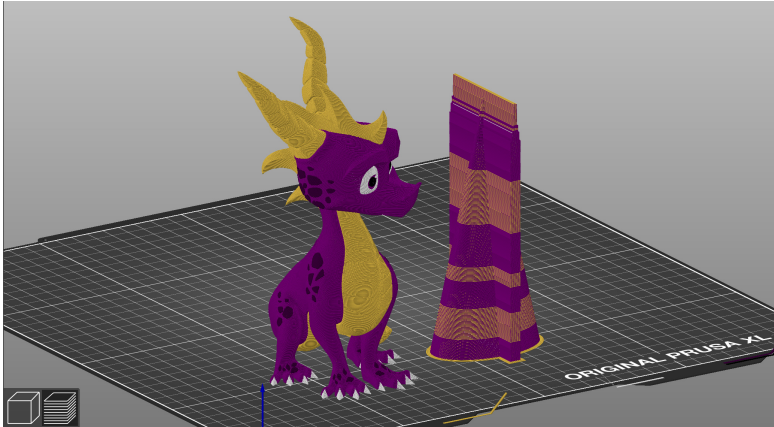

The priming tower settings can be altered in the Print Settings -> Multiple Extruders menu. However, the default values work for the vast majority of prints and we recommend keeping them untouched. In case you're encountering stability issues, you may consider changing the Width of the tower or the Stabilization cone apex angle.

Wipe tower	
● Enable:	<input type="checkbox"/> <input checked="" type="checkbox"/>
● Position X:	<input type="checkbox"/> <input type="text" value="201.2178"/> mm
● Position Y:	<input type="checkbox"/> <input type="text" value="57.9825"/> mm
● Width:	<input type="checkbox"/> <input type="text" value="60"/> mm
● Wipe tower rotation angle:	<input type="checkbox"/> <input type="text" value="90"/> °
● Wipe tower brim width:	<input type="checkbox"/> <input type="text" value="2"/> mm
● Maximal bridging distance:	<input type="checkbox"/> <input type="text" value="10"/> mm
● Stabilization cone apex angle:	<input type="checkbox"/> <input type="text" value="25"/> °
● Wipe tower purge lines spacing:	<input type="checkbox"/> <input type="text" value="100"/> %
● No sparse layers (EXPERIMENTAL):	<input type="checkbox"/>
● Prime all printing extruders:	<input type="checkbox"/>

4.8.5. Priming Tower Placement

As soon as you select Original Prusa XL Multitool in the Printer selection box, the priming tower will appear in the 3D preview. The preview shows its maximum footprint, because the size may decrease after slicing, based on the number of color changes in each layer. The size will decrease from the edge with the polyline.

You can change the placement of the wipe tower by dragging it with the left mouse button. Make sure the wipe tower doesn't intersect any of the objects. To shorten the travel moves between the object and the wipe tower, place it in the proximity of the object.



Wipe to Infill and Wipe Object functionality is still enabled for the Original Prusa XL Multi-Tool, but due to the way the purge tower is handled and how small it is, these functions are not as useful compared to MMU2S/MMU3.

4.8.6. Soluble Supports

Soluble supports are a type of support structure used in 3D printing that can be dissolved in a solvent, leaving the final printed object free of any unwanted support material. These support structures are typically made from water-soluble polymers such as PVA and BVOH. While the organic supports are the recommended option for a majority of projects, it's possible that your case will require grid supports with larger contact area.

We strongly suggest using Verbatim BVOH support material. The second best option is Prima Select PVA, both available in our e-shop. Unfortunately, the quality of different PVA brands can vary greatly and we cannot guarantee good results when working with soluble materials from other brands.

Since soluble materials are expensive, it may be a better idea to use them only as soluble interfaces - see the next chapter. In case you need to print the entire support structure from soluble supports, follow these instructions.

How to enable soluble supports:

1. Select Original Prusa XL Multi-Tool in PrusaSlicer.
2. Choose into which extruder you're going to load the soluble material (e.g., Extruder no. 2).
3. Select the type of material from the drop-down box (PVA or BVOH).
4. Go to the Filament Settings tab and choose this extruder in the top drop-down box (e.g., Extruder 5). Look at Filament properties directly below - it should say PVA (or BVOH) and the Soluble Material option should be ticked.
5. Go to Print Settings - Support Material and look for Options for support material and raft. You may need to switch to Advanced view to see all the options. If PrusaSlicer asks you if it should adjust settings for the priming tower, choose Yes.
6. Find "Top contact Z distance" and change it to "0 (soluble)".
7. Finally, go to Print Settings - Multiple Extruders and look for "Support material / raft / skirt extruder" and select Extruder no. 2.
8. Now slice the object as usual and you should see that the supports are printed exclusively with the soluble material.

4.8.7. Soluble Interfaces

Water-soluble filament is usually fairly expensive. In order to greatly reduce the amount of water-soluble filament needed, you can choose to print a soluble support interface only. With this option turned on, only the last few layers in contact with the model with being printed using a soluble filament.

To set up soluble interfaces, follow the procedure from the previous chapter (Soluble Supports). The only difference is in step 7. Instead of looking for "Support material / raft / skirt extruder" look for "Support material / raft interface extruder" and set the number to the number of the extruder with loaded soluble material. Then slice the object as usual and you will see that only a tiny interface between the object and the supports is printed with soluble material, greatly reducing the consumption and costs.

4.8.8. Removing Soluble Supports

When removing soluble supports, try to break away as much material as possible while the object is still dry. Then continue peeling the material under running warm water. The last bits can be removed by letting the print soak in warm water. Water-soluble filaments must be **always** stored in dry conditions.

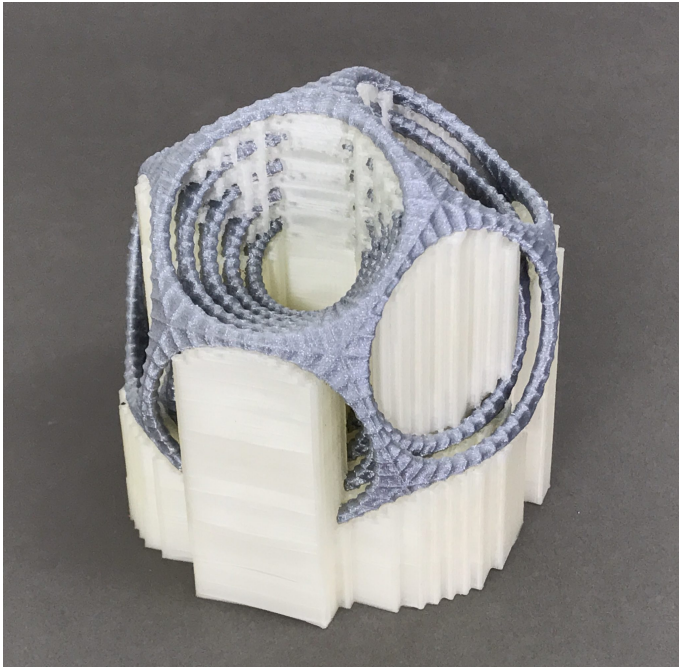

4.9. Slicing and Exporting

One of the most important phases of the slicing process is the final check of the sliced object in the Preview. Using the slider on the right, you can **review all the print layers** of the object one by one. This will help you **identify problematic spots** - for example, if the bottom of the object doesn't stick well to the bed or if some of the parts are missing supports and are "hanging in the air," rendering the object unprintable.



Before you export the model as G-code and upload it to the USB drive, always check it in the Preview first. It's the best way to avoid mistakes during printing.

To summarize:

1. Find a suitable 3D object for printing and download it (usually in .stl or .obj format)
2. Import the object into PrusaSlicer
3. Use the built-in tools to scale, move and rotate the object. Find the optimal orientation: large flat base, minimal overhangs
4. Add supports if necessary. If you're printing, e.g., a figure with a face, try to rotate the object so that the supports don't connect with the face or other areas that need to have pristine print quality
5. Select the infill type and density
6. Select the nozzle diameter (default is 0.4mm) and layer height
7. Slice the object
8. Inspect the preview
9. Export the G-code and print it

4.10. Using Nozzles with Various Diameters

The Original Prusa XL comes equipped with a **0.4mm nozzle by default**. This nozzle offers a great quality-speed ratio which comes in handy when you print huge objects.

However, for some projects, a nozzle of a diameter might be more suitable. The Original Prusa XL uses special nozzles with a metal filament guide, making them easy to swap and highly reliable.

We offer a wide range of nozzles of various diameters on our e-shop, ranging from 0.25mm to 0.8mm nozzles.

To give you even more options for your 3D printing projects, we developed a Nextruder to V6 nozzle adapter. When you install it, you can easily use any type of V6-compatible nozzles, including high-flow models. More information on alternative nozzles and their installation can be found at prusa3d.com and help.prusa3d.com.

5. Material Guide

A full table of materials is available online! Due to limited space within this guide, we can only provide a brief overview of popular materials here. Visit help.prusa3d.com/materials to find a **full overview of a wide range of printing materials**. The Original Prusa XL 3D printer is compatible with almost all filaments available. Individual materials may differ not only in color but also in mechanical and optical properties, or even in printing difficulty. If you have no experience with 3D printing, **we recommend starting with PLA**. Only if PLA filament is limiting you in any way, consider other materials such as PETG or ASA.



Prusament is our in-house made line of high-quality filaments. We were not satisfied with the quality of filaments on the market, so we decided to make our own! The whole manufacturing process is closely monitored and tested – string diameter, color consistency, and mechanical properties – to make sure that **every spool is perfect**. We are the only manufacturer that gives customers **the option to fully inspect the parameters of every filament spool**. Just scan a QR code on the spool to see all details online. We offer an entire range of various materials at prusa3d.com and it keeps growing every day!

5.1. PLA

PLA is the most commonly used material for 3D printing. It prints easily and prints from PLA are very hard. Perfect choice for printing large objects due to low shrinkage (prints don't warp on the bed) and for printing detailed small models.

Advantages

- Easy to print, suitable for beginners
- Easily print small detailed models
- Trouble-free printing of larger objects
- Almost odorless
- Affordable
- Wide range of colors

Disadvantages

- Brittle and inflexible
- Slightly worse temperature resistance (50-60 °C)
- Difficult post-processing
- Not suitable for outdoor use (low UV and temperature resistance)

Typical uses: Prototypes, toys, action figures, jewelry and small detailed models in general, architecture models and more!

Prints best on a smooth (or satin) print sheet. When post-processing PLA prints, it is best to use wet sanding to achieve better results. If you use sandpaper dry, the heat generated by friction can start to deform the printed object. PLA can only be dissolved in chemicals such as chloroform or heated benzene. For gluing, a good quality superglue is sufficient, certain types of PLA can also be glued with acetone.

- **Nozzle temperature:** 215 °C
- **Heated print bed temperature:** 50-60 °C
- **Print surface:** Make sure the print bed is clean, as per instructions in the Spring steel print sheets chapter.

5.2. PETG

PETG is one of the most popular materials for 3D printing. It is a great choice for parts that will be subject to mechanical stress. Compared to PLA, it has a higher temperature resistance, it is more flexible and less brittle. Thanks to its low thermal expansion, it holds well to the bed and does not warp. Printing with it is almost as easy as with PLA, but unlike PLA it offers much better mechanical properties. Parts of our printers are printed with PETG!

Advantages:

- Good temperature resistance
- Easy printing
- Low thermal expansion
- Durable and tough
- Easy machining (sanding)
- Printing almost without smell
- Glossy surface
- Good adhesion of layers.

Disadvantages:

- Not suitable for printing small/highly detailed models
- Nozzle can leave behind thin filament strands (stringing)
- Problematic bridging and overhangs
- Strong adhesion to the bed
- Cannot be smoothed with commonly available solvents, soluble only in dangerous chemicals
- Removal of supports can be difficult.

Typical use: Mechanical parts, Holders and cases, Waterproof prints (flower pots).

Tips and tricks:

PETG requires a higher heatbed temperature (85 °C). PETG usually has worse results when bridging two points, plus PETG tends to string - this means it's leaving fine plastic strings on the surface of the print (which can be relatively easily removed). Stringing can be reduced by setting appropriate retraction and using lower printing temperatures - we recommend sticking to the values in PrusaSlicer profiles. The print must be well cooled - it has better details and stringing can be prevented to some extent. However, if you want the most durable print, try turning off the print fan. A higher temperature will cause the layers to stick better to each other, resulting in better mechanical resistance. Generally, we recommend printing the first few layers with the fan turned off (for adhesion) and then turning it on at 50% power.

- **Nozzle temperature:** 240 °C
- **Bed temperature:** 70-90 °C
- **Print surface:** A textured print sheet and a satin print sheet do not require any special preparation, just keep them clean and free of grease. For a smooth print sheet, you should apply a thin layer of glue stick, as PETG may adhere too strongly to the sheet surface, making it difficult to remove prints from the sheet.



Do not print large PETG parts on the satin sheet - you might damage the surface. Instead, for large PETG prints use the textured powder-coated PEI sheet.

5.3. ASA (ABS)

ASA and ABS are very similar materials. In some respects, ASA is better than ABS. ASA is UV-stable compared to ABS and shrinks slightly less during printing. When it comes to post-processing, ABS and ASA can be similar, but the latter is currently more popular, so we will focus mainly on it.

ASA is a strong and versatile material. A higher melting temperature than PLA gives ASA good thermal resistance, so your prints will not show signs of deformation up to temperatures around 100 °C. Unfortunately, compared to PLA, ASA has a very high thermal expansion, which complicates printing, especially larger models. Even with a heatbed set to 100 °C, the print can start to warp and detach from the bed. ASA also produces a noticeable odor during printing.

Advantages:

- High impact and wear resistance (lower than PETG)
- Very good thermal resistance
- Suitable for outdoor use - UV stable
- Soluble in acetone - can be used for gluing
- Possibility of smoothing with acetone vapors
- Detailed prints without stringing (leaving fibers on the print)
- Easy post-processing (e.g. sanding, cutting, etc.)

Disadvantages:

- Difficult printing
- Tendency to warp (printing in an enclosed box is recommended)
- Unpleasant smell when printing (contains styrene)

Typical uses:

- Cases and protective covers
- Prototypes
- Spare parts
- Toys and figures
- Parts suitable for exterior use

Tips and tricks:

Printing with ASA/ABS is much easier if the printer is placed inside an environment with increased stable temperatures. This significantly reduces both deformation and layer separation. Thanks to acetone, it is easy to join several prints together. Just lightly rub the contact surfaces and press the parts together. In addition, it is possible to smooth the prints with acetone vapors and get a perfectly glossy surface. Be careful when handling acetone!

- **Printing temperature:** 220-275 °C
- **Bed temperature:** 90-110 °C (larger objects require higher temperature)
- **Print surface:** ASA and ABS materials work best with a satin print sheet, which requires no special preparation - just keep it clean and free of grease. However, if you are printing ABS/ASA on a grainy/smooth print bed, it is necessary to apply a glue stick.

5.4. PC (polycarbonate) and PC Blend

Polycarbonate (PC) is a technical material boasting excellent strength, tensile strength, and resistance to high temperatures. It is however quite demanding to print, thus making it suitable mainly for advanced users. This of course does not apply to our Prusament PC Blend, which is much easier to print compared to other polycarbonates. Polycarbonate surpasses all of the aforementioned materials in its mechanical, chemical, and thermal resistance.

Advantages

- High-temperature resistance
- High strength and tension resistance
- Clear polycarbonate is transparent
- Good electrical insulation properties

Disadvantages

- Pure polycarbonate is highly hygroscopic
- High nozzle and bed temperatures
- Strong warping, especially for large models
- Mild smell during printing
- Separating layer application recommended
- High price

Typical uses: Polycarbonate is mostly suitable for technical components, for which we require a higher resistance to mechanical wear and tear and high temperatures.

Tips and tricks: Consider printing in a closed box - to prevent warping of the printed objects; enable the "Brim" feature in PrusaSlicer - set it higher than the default outline, ideally to the whole height of the print; add a "Skirt" in PrusaSlicer around small objects; do not print in low-temperature zones;

- **Nozzle temperature:** 270-275 °C
- **Bed temperature:** 110 °C for the first layer, 115 °C for the following layers
- **Print surface:** Textured print sheet and smooth print sheet with a layer of stick glue offer the best adhesion properties. Although the textured print sheet offers good adhesion properties on its own, we recommend applying a separating layer of glue to prevent wear/damage of the surface.

5.5. PVB

Polyvinyl butyral (PVB) is a material that can be easily smoothed with isopropyl alcohol (IPA). Prints, when properly set up, are clear and transparent, thus making PVB a suitable material for printing vases, lamp shades, and other decorative models. The printing settings are similar to those for PLA, but the mechanical properties of PVB are slightly better.

Advantages

- Similar printing settings to PLA
- Transparent filament
- Suitable for decorative models - vases, lamp shades, etc.
- Chemical smoothing with IPA
- Good toughness
- Good tensile strength (similar to PETG and PLA)
- Less prone to warping (less than PLA)
- Suitable in combination with 0.8mm nozzle

Disadvantages

- Lower adhesion between layers
- Hygroscopic material (absorbs moisture)
- Higher price

Typical uses: PVB finds its best use when printing transparent (translucent) models – e.g. jewelry, vases, lamp shades, etc.

Tips and tricks: PVB has good adhesion to clean smooth or satin print sheet, while textured print sheets have rather poor adhesion. If you want to print translucent prints which you will later smooth with isopropyl alcohol, we recommend using a bigger nozzle (0.8mm) and enabling the "Spiral vase" mode in PrusaSlicer. When printing with multiple perimeters, the individual layers will be clearly visible even after smoothing with isopropyl alcohol. Store the filament in a dry environment – PVB is a material prone to absorbing moisture, which can negatively affect the quality of the print. Always return the filament to its plastic bag with silica gel, or let it dry for 4 hours at 60 °C before printing with it.

The main advantage of PVB material is that it can be smoothed with isopropyl alcohol (IPA). Models printed from PVB can be smoothed in IPA vapors, by immersing into an IPA bath, or by directly applying IPA on the object surface (by using a sprayer or brush). Detailed instructions can be found on our blog at blog.prusa3d.com.

- **Nozzle temperature:** 215±10 °C
- **Bed temperature:** 75 °C
- **Print surface:** Do not use the standard grainy print bed. PVB will better adhere to the clean smooth or satin print bed. Textured print sheets may not have sufficient adhesion properties.

5.6. Flexible Materials

Flexible filaments are typically very strong and elastic materials. In many cases, the classic hard plastic (PLA, PETG) may not be ideal or even completely unsuitable for certain models. Whether you are printing a phone case, a housing for an action camera or even wheels for an RC car, it is better to use a flexible material. These materials are often expensive and not very common and are not suitable for beginners.

Before you start printing with Flex, clean the nozzle from the previous material by inserting PLA into the preheated extruder and pushing out all the previous material. For Original Prusa 3D printers, we recommend using Semiflex or Flexfill 98A, or Filatech FilaFlex40, for which we have tuned profiles in PrusaSlicer. Feeding flexible filament into PTFE tubes is more demanding - feed the filament gradually and don't apply too much pressure.

Advantages:

- Flexibility and elasticity
- Minimal shrinkage
- Excellent adhesion of layers
- Great resistance to wear

Disadvantages:

- Requires a special procedure for inserting filament
- Very poor bridging and overhangs
- Requires lower print speed
- Higher price
- Absorbs moisture - must be stored in a dry environment

- **Nozzle temperature:** 220 - 260 °C
- **Bed temperature:** 40 - 85 °C. (larger objects require higher temperature)
- **Print surface:** If you are printing on a smooth or satin print sheet, apply a separation layer to it! A glue stick is ideal. Textured sheets with a powder-coated PEI surface do not require a separation layer - the print will hold well and can be easily removed from the sheet after cooling.

5.7. PA (Polyamide) / PA11CF

Polyamide (also known as Nylon) is a versatile material known for its durability and is commonly used for 3D printing special models due to its high difficulty in printing (not applicable to PA11CF) and higher costs. There are several types of polyamide, which differ in properties such as temperature resistance, water absorption and adhesion to different types of surfaces.

Prusament PA11CF has great temperature resistance (up to 192 °C), strong resistance to a range of chemicals, and prints easily. Some polyamides, including the PA11CF, are reinforced with carbon fibers to reduce shrinkage, often at the expense of mechanical strength. We recommend the PA11CF for printing extremely stressed parts, such as plastic engine components, etc.

Advantages:

- Great temperature resistance (can reach up to 192 °C)
- Resistance to a range of chemicals
- Hard and resilient in thick layers, flexible in thin layers
- Smooth glossy surface of clean PA
- Excellent layer adhesion
- Suitable insulation material

Disadvantages:

- Not suitable for printing small/highly detailed models
- Prone to warping (not applicable to PA11CF)
- Challenging bridging and overhangs
- Strong (or too weak) adhesion to the surface
- Cannot be smoothed with commonly available solvents, dissolvable only in dangerous chemicals
- Difficult to remove supports
- Highly hygroscopic material

Typical use: Mechanical parts, holders and housings, electrical insulation parts, movable parts, and parts requiring great temperature resistance.

Tips and tricks:

It is absolutely essential to keep the filament dry, otherwise its adhesion and overall printing quality will significantly worsen. Therefore, we recommend drying the filament for at least 4 hours at a maximum temperature of 90 °C before printing. The print from a dried polyamide should have a smooth and glossy surface, while materials reinforced with carbon fibers have a matte surface.

When printing polyamides, we recommend using an enclosed printer with active filtration or keeping the printer in a well-ventilated room. Not only are potentially hazardous particles released when printing (all) PA, but the higher ambient temperature also reduces warping and improves layer adhesion. Carbon-reinforced polyamides can be printed without a covered printer, but due to the internal tension caused by the sudden temperature change, the finished prints may have slightly worse mechanical properties.

- **Nozzle temperature:** 240 - 285 °C
- **Bed temperature:** 70 - 115 °C

- **Print sheet surface:** For printing most polyamides we recommend using our special PA Nylon print sheet, which ensures ideal adhesion even when its only cleaned with water. However, the adhesion of some types of polyamide may be too high, leading to damage to the sheet, so we recommend checking the compatibility in our material table (help.prusa3d.com/materials). We do not recommend printing polyamides on a smooth print sheet, and when using a textured or satin sheet a layer of paper glue (glue stick - Kores) must be applied.

6. Regular Maintenance

The Original Prusa XL was designed from the beginning as a true print "workhorse". Despite its high reliability, it is still a device with mechanical components that require more or less regular maintenance. Follow the instructions below to keep your printer in perfect condition for as long as possible.

6.1. Flexible Print Sheets

To achieve the best adhesion of the print surface, it needs to be kept clean. Choose the right cleaning agent depending on the type of print sheet (see below). Drop a small amount of the agent onto a clean paper towel and wipe the print surface. Best results will be achieved when the print sheet is cold, otherwise, you may burn yourself on the nozzle or heated bed. Also, the alcohol will evaporate before it has a chance to clean anything. Details can be found in the chapter **Your First Print** in this manual.

The effect of various print sheets on the first layer can be seen below. From left to right: smooth, satin and textured powder-coated print sheet.



The print surface does not need to be cleaned before every print, just be aware of not touching it with your fingers.

Recommended cleaning agents differ slightly depending on the type of print sheet. Instructions for the use of specific materials (e.g. the need to use a separation layer to avoid damaging the surface) can be found in the previous chapter.

	Correct usage:	Risks and dangers:
Print sheet with smooth PEI surface	<ul style="list-style-type: none"> • Isopropyl alcohol 90%+ (IPA) is the best option for degreasing. Do not use dermatological hand products which may contain isopropyl alcohol - they contain other additives (ointments, hydrating ingredients). • Warm water with a few drops of dish soap (in case IPA does not remove residues like sugar from the bed) • Acetone - occasionally for thorough cleaning of the print sheet • When printing with Flex material you need to apply glue stick (Kores) 	<ul style="list-style-type: none"> • Prints from PETG would stick too strongly to the sheet cleaned with isopropyl alcohol (IPA) and removing it could damage the surface. Materials such as PETG, ASA, ABS, PC, CPE, PP and FLEX should only be printed with a separating layer (glue stick).
Print sheet with a textured powder-coated surface	<ul style="list-style-type: none"> • Isopropyl alcohol 90%+ (IPA) - best for degreasing 	<ul style="list-style-type: none"> • Do not use acetone
Satin print sheet	<ul style="list-style-type: none"> • Suitable for PLA and PETG • 90% isopropyl alcohol (IPA) is the best degreaser • For printing flexible filaments you need a separating layer of glue (Kores) • Broad spectrum of supported materials; including advanced materials such as PC Blend and others 	<ul style="list-style-type: none"> • Never use acetone! • For printing ASA and PC Blend you need to add a brim, outline or shield around the print • Do not use sharp objects to remove the print from the bed!



Consumable materials such as print sheets are not covered by our warranty unless they arrive damaged or incorrectly manufactured. Print sheets are consumables and the warranty only applies to defects that appear immediately after unpacking.



All original print sheets made in Prusa Research are double-sided.

6.1.1. Double-Sided TEXTURED Print Sheet

- Surface resistant to damage and scratches
- Texture on the surface of the sheet is transferred to the bottom side of the printed object
- Simpler Z-axis calibration
- FLEX does not require glue (Kores) application to the print bed
- After the print sheet cools down, the print usually detaches itself
- PLA prints with small contact area may require a brim
- Large PLA prints may warp
- **Never clean with acetone**

The textured powder-coated surface applied directly to metal allows us to create a print sheet that is highly resistant to damage. If a heated nozzle hits it, the metal is able to quickly dissipate heat. **The textured powder coating also gives the bottom surface of the print a unique, interesting texture.**

The textured surface is able to mask most scratches and similar types of damage caused by various tools. One can only scratch the highest points of the texture, yet this type of damage will not be visible on the print.



Never clean the textured powder surface with acetone! This will cause micro-cracks in the PEI layer, which will eventually lead to a significant deterioration of the surface quality.

6.1.2. Double-Sided SMOOTH Print Sheet

- Excellent for PLA
- Great adhesion to almost all materials
- Smooth bottom layer of prints
- Even small prints will hold well
- Occasionally clean with acetone

For printing materials such as PETG, ASA, ABS, PC, CPE, PP, Flex and others, it is necessary to apply a glue separation layer. More information can be found in the Materials Guide.



The industrial adhesive used to attach the PEI layer to the print sheet tends to soften at temperatures above 110°C. The adhesive can then move beneath the surface, creating small bumps.



If you notice small bubbles appearing beneath the PEI layer on the flexible print sheet, just flip it over and print on the other side. After a few days or weeks, the bubbles should disappear. The bubbles have no effect on the print quality.

6.1.3. Double-Sided SATIN Print Sheet

- Suitable for PLA and PETG
- Soft texture on the bottom part of the print
- **Only use quality isopropyl alcohol (90+ %) to clean**
- FLEX requires the use of a glue separation layer (Kores) on the print sheet
- Wide range of supported materials, including advanced materials such as PC Blend and more
- Easy maintenance and good adhesion
- **Do not use acetone! Acetone will damage the surface of the print sheet!**
- When printing with ASA and PC Blend, a brim or a raft may be required around the print, depending on the model height
- **Do not use sharp metal objects to remove prints from the sheet (e.g. a metal spatula)**

6.1.4. Improving the Adhesion

In certain special cases, such as printing a very tall object that touches the print sheet with a very small area, it may be necessary to **improve the adhesion**. PEI is fortunately a chemically very resistant polymer, so it is possible to **apply various substances to improve adhesion without risking damage to the surface**. This also applies to various materials whose adhesion to PEI would be very weak under normal circumstances. More information can be found on the website help.prusa3d.com/materials.



Before applying anything to the print sheet, consider using the Brim feature in PrusaSlicer to increase the area of the first layer.

6.2. Keeping the Printer Clean

After several hours of printing, various kinds of debris may start to accumulate inside the printer under the heatbed - pieces of filament, dust, scraps, broken supports, etc. Always make sure that the internal parts of the printer are clean. You can use a brush, small broom or a vacuum to remove debris from the inside of the printer.

6.3. Linear Rails

Depending on the dustiness of the environment, you should **wipe the linear rails with a dry tissue every few dozens or hundreds of hours of printing** - never use wet wipes, sponges, etc. - linear bearings must not come into contact with water and degreasers.

This is all that is required for regular maintenance of the linear rails. It is not necessary to apply any sort of lube or grease onto the rails.

6.4. Threaded rods

In case the Z-axis threaded rods start producing a creaking/squeaking noise after several dozens or hundreds of hours of printing, use the enclosed Prusa Lube to lubricate the threaded rods. You

can download a 3D-printed applicator from [Printables.com](https://www.printables.com). More info can be found at help.prusa3d.com.

6.5. Fans

The RPM (revolutions per minute) of both fans is constantly measured. This means that the printer will **report an error if the fan suddenly slows down**, for example due to a piece of filament stuck in it. In such a case, check and remove any dirt from the relevant fan. Do not try to bypass the RPM check - this could damage the printer!

Both fans should be checked and cleaned after a few hundred hours of printing. Dust can be removed with compressed air in a spray can, small plastic threads can be removed with tweezers. **Do not blow compressed air on the running fan.**

6.6. Extruder Feeding Gear

The feeding gear in the extruder does not need any lubricant. Over time, **a filament powder deposit may form in the grooves**, causing poor extrusion of filament. Remove the debris using compressed air in a spray, small plastic threads can be removed with tweezers. Use the access opening on the side of the extruder. Clean as much as possible, then turn the wheel (LCD Menu - Control - Axis) and continue.

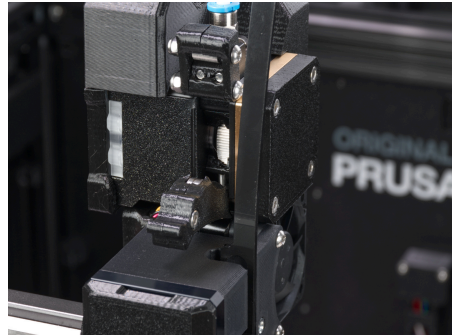
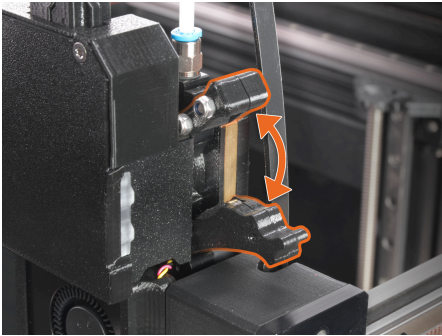

Warning: Never, under any circumstances, open the gearbox itself. Tampering with the gearbox may lead to voiding your warranty.

6.7. Extruder is Clogged or Jammed

Clogged extruders can cause issues when printing or when loading new filament. On the top of the extruder, there is a pair of screws directly next to the filament inlet. You can adjust the idler pressure by loosening or tightening these screws. By unlocking the top clip, you can open the hinged door (the so-called idler) and check the filament track for any blockages.

When you open the idler, you can easily clean the feed wheel of all filament remnants. We recommend regularly cleaning the wheel.

6.8. Cleaning the Nozzle



Do not touch the nozzle during this procedure - it is hot and there is a risk of burning yourself! To better access the extruder during cleaning, lower the heated bed as far as possible in the LCD menu - Control - Movement - Z Axis.

The filament does not come out of the nozzle

If the filament does not pass through the extruder and no plastic is being extruded, check the following:

- Open the idler on the side of the extruder to see if the filament strand reached the extruder gear and continues down into the nozzle
- See if the temperatures are set correctly (215 °C for PLA, 260 °C for ASA, etc.)
- Check if the fan on the side of the extruder is spinning

If the filament strand is not visible (does not reach the extruder wheel), the problem is likely in the PTFE tubes. Take advantage of the fact that the tubes are transparent and check where the filament currently is and if it reaches the extruder. If the filament does not pass smoothly and gets stuck, make sure that there is no debris in the PTFE tubes and that your filament has the correct diameter and quality - various bumps, etc. can cause the filament to get stuck. Try to cut off a roughly 130 cm (4 ft.) long piece and repeat the filament insertion attempt.

The filament does not come out of the nozzle or only a small amount comes out

If you see that the filament passes across the extruder gear but does not come out of the nozzle, it means that the nozzle is probably clogged. You can clean it as follows:

1. Heat the nozzle to the appropriate temperature for the filament material you are printing with or slightly above. First, feed the filament, then insert an acupuncture needle (included in the package) or thin wire (0.3-0.35 mm) into the nozzle from the bottom to a depth of about 1-2 cm. Use protective gloves in case material suddenly starts to come out of the nozzle.
2. Select the Load Filament option from the LCD menu and check that the nozzle is actually extruding the filament.
3. Again insert the wire or acupuncture needle into the nozzle and repeat the whole procedure several times. If the filament is being extruded correctly, the nozzle is clean.

Remember that you can also remove the Nextruder from the dock manually - slide it to the side and tilt it to unhook it from the dock. This gives you better access to its components.

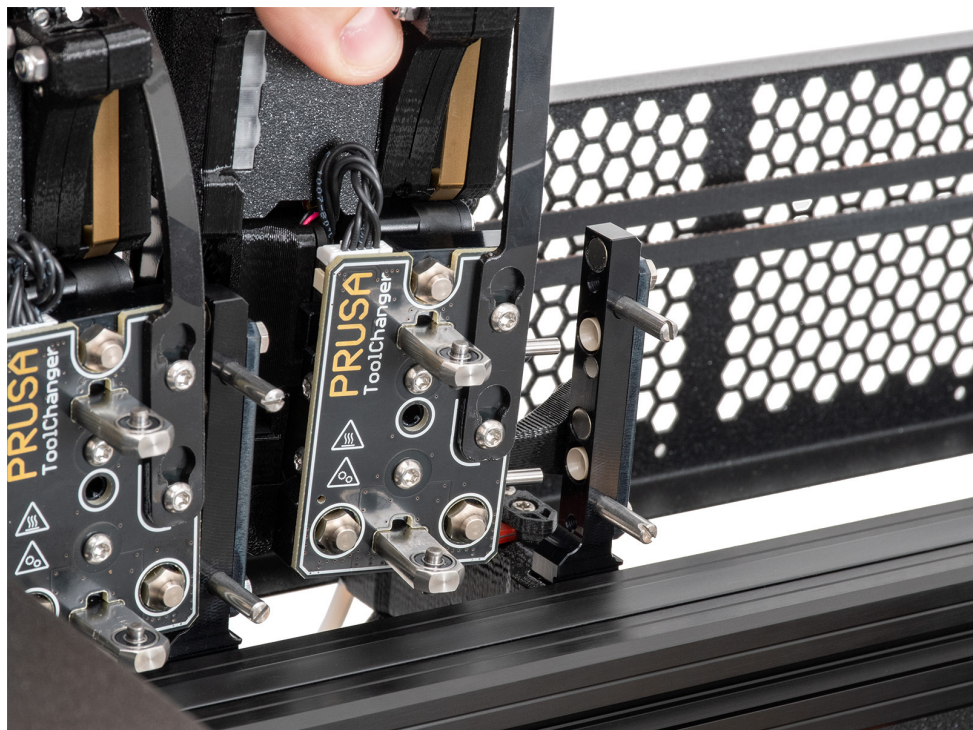

6.9. Troubleshooting Faulty Sensor Readings and Removing Errors

If you encounter problems with the filament sensor, such as incorrect (or random) readings, make sure the sensor is correctly wired. If the problem persists, please contact our tech support.

6.10. Filament Sensors

Original Prusa XL is equipped with multiple filament sensors: the first one is always located on the side, close to the input of the PTFE tube where you feed the filament. The second one is located in the extruder. If you have the Original Prusa XL with multiple extruders, there will be a corresponding number of filament sensors. Both filament sensors are necessary for the correct filament retraction - when the sensor on the side detects that the filament has run out, the filament will be retracted in time. If everything depended just on the filament sensor in the extruder, it would not be possible to easily retract the filament.

6.11. Toolchanger Maintenance and Troubleshooting

The toolchanger is designed to be maintenance-free. There are no regular maintenance operations that need to be carried out. Simply keep the toolchanger carriage clean and free of debris. Make sure none of the dock pins are bent or damaged in any other way.

If you encounter issues with the toolchanger, e.g., when the toolheads are not correctly picked up or parked, run the calibration again (Dock Offset and Tool Offset). If there is an issue with the printer, the calibration will display an error screen describing the issue. Contact our tech support if you are unable to resolve the situation on your own.

6.12. PTFE Tubes Maintenance

PTFE tubes leading to individual extruders are mostly maintenance-free. However, if they are damaged or full of debris, it may be necessary to replace them with new ones - you can order spare parts from our e-shop.

6.13. Nozzle Seal Maintenance

When an extruder is parked, the nozzle is resting on a small metal lip with a silicone surface that prevents the filament from oozing out. In some cases, plastic debris may accumulate on the surface which makes parking the extruder more difficult. Check this area from time to time and remove any excess plastic if needed.

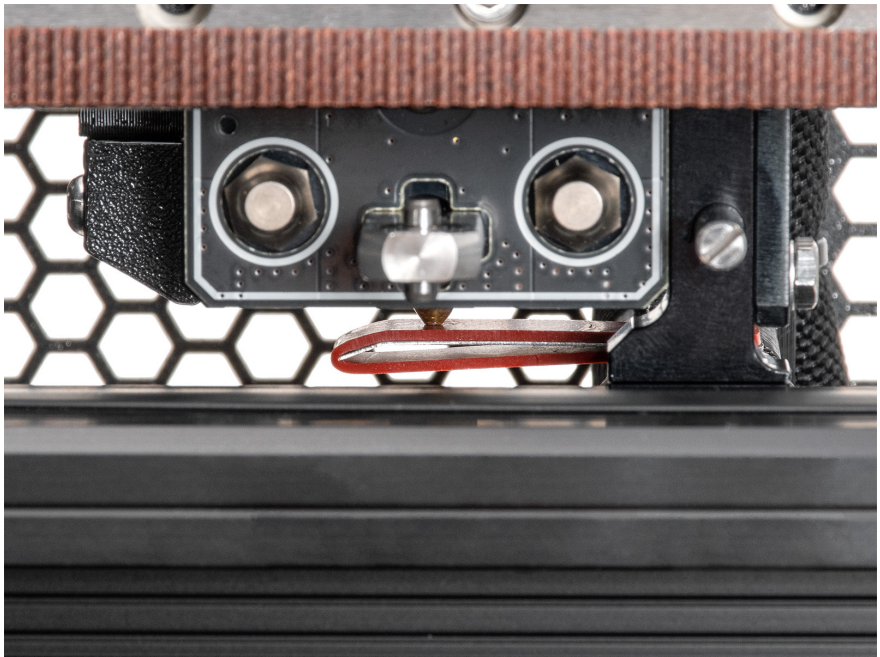

6.14. Flashing an Unofficial (Unsigned) Firmware:

We take security seriously. Before each firmware update, we rigorously test it to ensure that all of its security features are working correctly. **If any of the sensors detect an unexpected reading, the heater will be immediately disconnected to prevent any damage to the printer or its surroundings.** We cannot guarantee the same level of security with unofficial (community) firmware.



Official firmware is signed with a private key and the printer verifies the key before updating. To flash your own (or unofficial) firmware to the printer, **you must first break the seal on the mainboard** and place a jumper in the correct position. **Doing this voids the electronics warranty.** To break the seal, you must open the electronics box and locate a safety fuse. Then, **take a small flathead screwdriver or very thin sharp pliers and break off the thin middle part** of the fuse. **Before attempting this procedure, carefully review the photos in this chapter!** Breaking the seal is **irreversible** and is recommended only for very experienced users. Afterward, **focus on the three pins above the seal** – it is necessary to place a jumper on two of the pins closer to the center of the board. If the jumper is on different pins, move it. Without the jumper, the board cannot boot.



Breaking the seal on the mainboard of the Prusa XL is **IRREVERSIBLE** and leads to the **VOIDING OF THE WARRANTY ON ELECTRONIC PARTS OF THE PRINTER**. If you break the seal, we disclaim any responsibility for any damage to the printer and/or its surroundings (e.g. in case of a fire).

7. FAQ - Frequently Asked Questions and Basic Troubleshooting

In case of a critical failure, the Original Prusa XL may display an error screen with short instructions on how to proceed. This screen contains a link to a detailed article on our Knowledge Base at help.prusa3d.com as well as a QR code that can be scanned by a mobile phone to quickly access the link.

7.1. Mesh Bed Leveling Fails

In case the automatic bed leveling (Mesh Bed Leveling) fails, the cause is likely to be either the Loadcell sensor or a misaligned Z axis. Run the Auto Home and Z axis calibration from the Control menu and see if the issue goes away.

If the issue persists you can manually inspect whether the Z-axis (heatbed) is correctly aligned. Disable the stepper motors in the settings (Disable Stepper Motors) and manually move the print head from left to right and watch if the nozzle maintains a constant distance from the bed.

Small deviations are allowed as the printer is able to compensate with Mesh Bed Leveling. If the nozzle is scraping against the print sheet on one end and is several millimeters above the sheet on the other end, then the Z-axis is misaligned.



If you built the printer using the assembly kit, make sure that the heatbed assembly is correctly installed and aligned. Follow the assembly guide and double-check every step.

7.2. Printer Does Not Recognize the Inserted USB Drive

If the printer does not recognize the USB drive, try restarting the printer first. In case the error "Error mounting USB drive" appears, the most probable cause is an incompatible file system (e.g. exFAT). Use a smaller USB drive (4-16GB) formatted with the FAT32 file system. More information on formatting and using USB drives can be found on our Knowledge base at help.prusa3d.com.

Once the USB drive is inserted, one of two situations may occur:

Cannot access the Print menu after inserting the USB drive

1. Restart the printer first
2. Use a USB drive formatted to FAT32 with a single partition
3. Try using a different USB drive

If you have tried multiple USB drives and none of them can be read, there may be a problem with the mainboard. Contact our technical support.

USB drive is recognized but no files are visible in the file browser:

1. Make sure you are using compatible G-code
2. Make sure the file is correctly written to the drive (in Windows use the “Safely remove” function before ejecting the drive)
3. Try a different USB drive and a different G-code file
4. Try renaming the file to something simpler, e.g. model.gcode

7.3. Loose Belts

Check both belts to make sure they are properly tensioned. Loose belts can cause printing errors or prevent the printer from starting up. The easiest way to check the belt tension is to print a circular object. If the result is not perfectly round, you need to adjust the belt tension. Instructions can be found at help.prusa3d.com.

7.4. Homing Failed

This issue is usually caused by a blockage in one or more axes. Perform the Auto Home calibration from the LCD Menu and observe the movements of the printer. Make sure the cables and PTFE tube leading to the extruder are not touching anything (a wall, shelf, etc.) If there is no visible block preventing the axes from moving, try adjusting the Crash detection sensitivity in the Settings menu.



If you assembled the Original Prusa XL as a kit, make sure that the cables running from the electronics to the extruder are not blocked by anything. Make sure the cable assembly is correctly installed - when looking at the front of the printer, the PTFE tube should be on the left, the cable bundle on the right.

7.5. Heating Error

If the printer stops and the screen is red with a heating-related error, please check the connections of the heating element and thermistors. Detailed descriptions can be found at help.prusa3d.com.



If you assembled the printer using the assembly kit, pay special attention to the electronics box under the heatbed. Go back to the assembly manual and check that the heatbed is wired correctly (A and B ports, positive and negative terminals).

7.6. Fan Error

If your printer stops and displays a fan-related error message, check both fans on the print head. It is possible that they are not spinning because they got clogged up. If the problem is elsewhere (e.g. cables connectivity) visit help.prusa3d.com for more information. Before you start with more advanced troubleshooting, make sure you're running the latest firmware available from our website.

7.7. Reverting to an Older Firmware

Sometimes it is necessary to reinstall an older version of firmware. Upload a file containing the older firmware onto a USB drive formatted with the FAT32 system. Insert the drive into the printer, press the restart button and once the Original Prusa XL logo appears on the screen, press and hold the knob. This will activate the firmware update screen. Select "Flash" to reinstall the current firmware with the version from the USB drive.

7.8. Nozzle Hitting the Sheet / Other Z-axis Issues

If you are having issues with first-layer calibration or Mesh Bed Leveling procedure, first make sure everything is properly wired - check the connectors on the Dwarf board in the extruder. Next, perform Auto Home calibration on all axes to make sure that everything is properly aligned (especially the heatbed). Run the Loadcell calibration again.

8. Advanced Hardware Troubleshooting

Due to the length of the articles, it is not possible to include detailed troubleshooting guides in this handbook. However, the Original Prusa XL will display an error screen with a short recommendation on how to proceed further if it runs into a problem. This screen will also contain a link to a detailed article in our Knowledge Base at help.prusa3d.com. Additionally, there is a **QR code that you can scan with your mobile phone** for quicker access to the link.

Troubleshooting guides for component replacements and advanced hardware issues can be found online at help.prusa3d.com.



9. Troubleshooting Print Quality Issues

If prints are not quite up to your expectations or even having major flaws (shifted layers, ghosting, under-extrusion), it is necessary to find the cause of the issue and address it. On our website help.prusa3d.com you will find troubleshooting guides for 3D printing quality issues, including pictures and specific advice for different types of printers (some of which may still be in English only).

10. Original Prusa PDU - Manual

The Original Prusa PDU is a power strip with a noise filter designed to power 3D printer power supplies. Please read the following text carefully - it contains valuable information to help you properly maintain and operate the device.

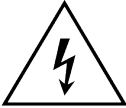
If you encounter any issues while using the product, do not hesitate to contact us at info@prusa3d.com. You can also visit our help center at help.prusa3d.com or our discussion forums at forum.prusa3d.com.

	Caution, danger of electric shock.
	Protective grounding, terminal for connecting the protective ground wire
	This device is made up of components that need to be disposed of in accordance with the Waste Electrical and Electronic Equipment Directive.

Product Information

Name:	Original Prusa PDU
Manufacturer:	Prusa Research a.s., Partyzanska 188/7a, 170 00, Prague, Czech Republic
Contacts:	Phone: +420 222 263 718; Email: info@prusa3d.com
Device usage:	Indoor use only
Power supply:	100-240 VAC, 10 A max, 50-60 Hz
Protection class:	I
Ingress protection:	IP20 - protect against the ingress of water in any form
Operating temperature range:	18 °C - 38 °C
Maximum air humidity:	85 %, non-condensing

Product dimensions:	Width: 430 mm
	Depth: 62 mm
	Height: 75.5 mm
Weight:	1200 g

The product's serial number can be found on the type label located near the switch.

This device is intended for indoor operation, where it is protected against external influences.

Warranty

The Original Prusa PDU is covered by a 24-month warranty for end customers in the EU and a 12-month warranty for corporate customers. Consumable parts and parts subject to normal wear and tear are excluded from this warranty. The warranty period begins on the day the customer receives the goods. The seller is not responsible for damages caused by improper handling of the purchased product or damages resulting from handling that is contrary to the information and recommendations provided in the official manuals. The warranty also becomes void in case of unprofessional interventions and the use of unofficial hardware and software modifications.

Disclaimer

Actions contrary to the information provided in the manual may result in injury or damage to the Original Prusa PDU. Ensure that anyone working with the device is familiar with and understands the content of the manual. Since we do not have control over the conditions in which you operate the device, we assume no responsibility and expressly disclaim liability for any losses, injuries, damages, or expenses incurred or in any way associated with the handling, storage, use, or disposal of the product. The information in this manual is provided without any warranty, expressed or implied.

Exercise extreme caution when handling the Original Prusa PDU. It is an electrical device.

Description of important parts

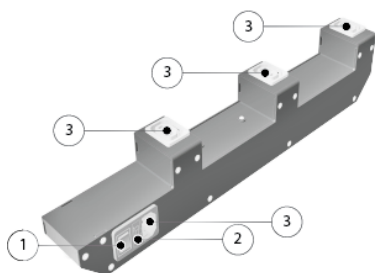

- 1. Switch
- 2. Fuse holder
- 3. Connector

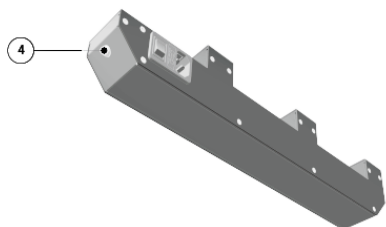

- 4. Screw terminal for protective conductor
- 5. Mounting hole

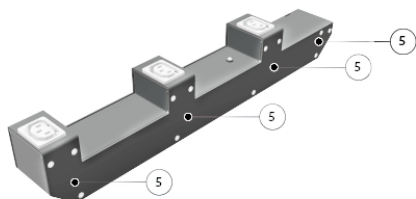

Assembly procedure

There are no user-serviceable parts inside the product. Opening the cover exposes you to the risk of electric shock and voids the warranty.

To install the Original Prusa PDU on your device, use the designated mounting holes and M4 screws.

Placement and Basic Use

Ensure that the device is located and operated in a suitable place to prevent any potential risks.

- This device is intended for indoor use only. Do not expose the device to water or snow. Contact with water and other liquids can damage the electronics, cause short circuits, and other types of damage. Always operate the product in a dry environment.
- Disassembling the product is prohibited as it may result in electric shock.
- If the product has suffered physical damage, do not use it. Damaged parts of the product may pose a safety risk.
- The power cable must be placed in a way that it cannot be tripped over, stepped on, or otherwise damaged. Ensure that the cable is not damaged. If it is, immediately stop using the device and replace the cable. Damaged cables pose an electrical shock hazard.

Electrical Safety

To prevent the risk of electric shock, follow the instructions below.

- The Original Prusa PDU can only be powered through a standard socket with 230 VAC, 50 Hz, or 110 VAC, 60 Hz. Never use alternative power sources as they can cause problems or damage the product.
- Never use the Original Prusa PDU if the power cable is damaged in any way. Damaged cables can cause electric shock.
- When disconnecting the power cable from the socket, do not pull on the cable but on the plug. This reduces the risk of damaging the plug or socket.
- Do not disassemble the product as it does not contain any parts that an unqualified person can repair. Always refer the product to a qualified service technician. Improper interventions can result in product damage and the risk of electric shock.
- The cross-section of the conductors in the flexible supply cord must be a minimum of 1.5 mm², and a three-core supply (L, N, PE) must be used.
- Disconnect the device from the power supply by pulling out the plug. The electrical socket must be easily accessible.

The Original Prusa PDU is equipped with a replaceable fuse located in the fuse holder at the connection connector, protecting the entire product. Before replacing the fuse, turn off the product, disconnect the power supply by pulling out the power cable from the socket, and then disconnect the power cable from the connector. Slide out the fuse holder using a flat screwdriver, remove the fuse, and insert a new one. Slide the fuse holder back in. Always ensure that the new fuse has the same value as indicated on the label (F10AH/250V). If the fuse repeatedly blows, contact service.



Printables

by JOSEF PRUSA

**PRINT AND SHARE!
JOIN OUR COMMUNITY!**

Download 3D models for free
at [printables.com](https://www.printables.com) and participate
in design contests!

**Follow us for tips, guides,
inspiring videos and amazing 3D prints!**

Share your prints with

#printedbyprusa

